

QolorFLEX[®]

PROFESSIONAL LED LIGHTING



CITY
THEATRICAL

NEW YORK • LONDON

An Environmental Lights Company

QolorFLEX[®] Quad Chip RGB Amber Plus Deep Red LED Tape

About QolorFLEX

City Theatrical's QolorFLEX® brand of LED Lighting is recognized for its superior quality, versatility, and variety. Created specifically for lighting professionals working in theatrical, television and film, and architectural applications, our goal was to produce a premium product line offering designers a variety of configurations of tape that could be incorporated into their projects easily. Backed by City Theatrical's superior technical expertise and support, QolorFLEX LED Tape is now used on hundreds of productions and in environments across the globe.

In addition to the original QolorFLEX LED Tape, the brand now includes a wide array of wired and wireless dimmers, our plug and play QolorPIX® Pixel Controlled LED Tape system, and QolorFLEX NuNeon® linear lighting and accessories – making it the professional's brand of choice for distinctive, dependable LED lighting products.



Learn more about QolorFLEX in the overview video at: <https://youtu.be/inPg3uOmpVo>



Ways You'll Benefit

High Quality Products That Work

QolorFLEX products are all professional grade, tested, and trusted. All LED tapes under the QolorFLEX brand are ETL listed and CE and RoHS compliant.



Maximum Creative Potential

We offer a complete line of tape, dimmers, accessories, and more so lighting and scenic designers can maximize their creative vision for a performance or installation.

Easy To Work With

QolorFLEX products are all installation friendly with a variety of mounting and wiring accessories available.

Long Lasting Performance

Our LED Tape products meet or exceed industry standards for service life.

Consistent Color Matching

Our LEDs are binned to assure that your tape will always match if you buy several units together or replace one at a time.

Support When You Need It

The QolorFLEX line is backed by the support and knowhow of the City Theatrical team – the best in the business for over 35 years.

QolorFLEX LED Tapes: 40+ Varieties including HiQ High CRI

Professional Grade LED Linear Lighting

The QolorFLEX LED Tape line is complete with 40+ types of high quality tape to add to any designer's toolkit. All QolorFLEX LED Tape is ETL listed, and CE and RoHS compliant, and sold in five meter reels with six-inch pigtails soldered on both ends for easy connections to dimmers.

Available in 12 and 24 volt and indoor and outdoor configurations, our white tapes range in color temperature from warm white, at 2700° K, to daylight, at 6500° K. We also offer an adjustable dual white for fine-tuning the color balance, three and four color tapes, like RGB and RGBA, to create thousands of colors, and five color "5-in-1" tape for ultimate color control. Additional QolorFLEX LED Tapes include HiQ High CRI for film and television, and 395 UV.

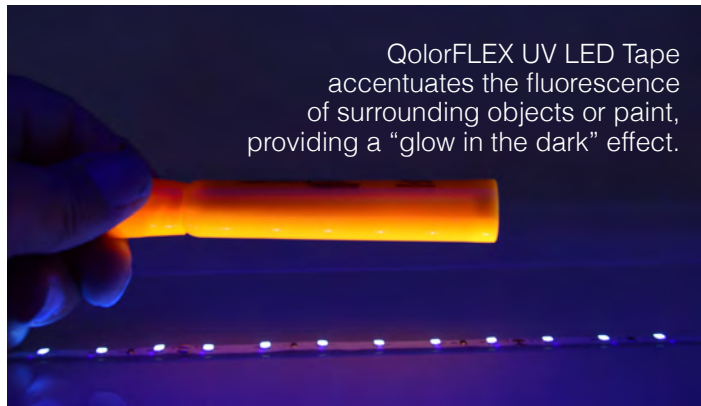
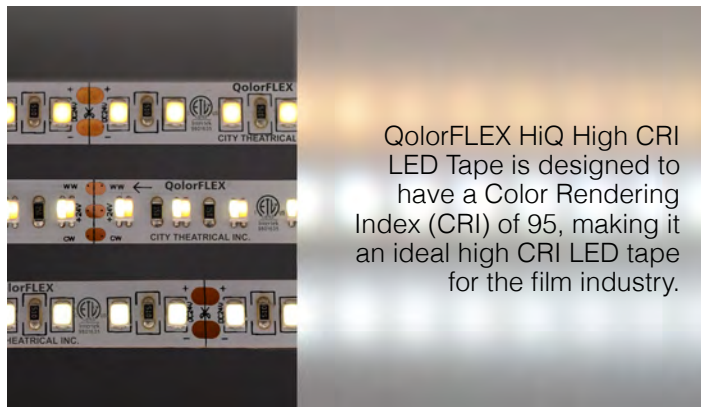

“We chose QolorFLEX because we knew it would give us the look and flexibility we were going for, and also because we’ve used it for other installations without having to replace it for years.”

- Mark Miskimen, President, ACME Corp.
Production Resources, Milwaukee, Wisconsin
([Read the Lakefront Brewery case study](#))



QolorFLEX LED Tape



City Theatrical's QolorFLEX brand of LED Lighting is recognized for its superior quality, versatility, and variety. Created specifically for lighting professionals working in theatrical, television and film, and architectural applications, our goal was to produce a premium product line offering designers a multitude of configurations that could be incorporated into their projects easily. Backed by City Theatrical's superior technical expertise and support, QolorFLEX LED Tape is now used for numerous productions and environments across the globe.

Sample Note:

To order 18" (45cm) samples of QolorFLEX LED Tape, change the Part Number length specifier to "0".

Example:

5050-12-NW-60-5-20-1

↑
Length (m)



QolorFLEX LED Tape Specifications

24V LED Tapes:

| | NAME | VOLTAGE | USE | BACKING COLOR | COLOR TEMP | LED SIZE | LEDs/M | LENGTH | PART NUMBER |
|-----|------------------|---------|--------|---------------|-----------------|----------|--------|--------|------------------------------|
| NEW | HiQ 3200°K | 24 | Indoor | White | 3200°K | 2835 | 120 | 5m | 2835-24-H3200-120-5-20-1 |
| NEW | HiQ 6000°K | 24 | Indoor | White | 6000°K | 2835 | 120 | 5m | 2835-24-H6000-120-5-20-1 |
| NEW | HiQ 2700-6500°K | 24 | Indoor | White | 2700°K, 6500°K | 3527 | 120 | 5m | 3527-24-H27006500-120-5-20-1 |
| NEW | UV | 24 | Indoor | White | N/A | 2835 | 60 | 5m | 835-24-UV395-60-5-20-1 |
| | Cool White | 24 | Indoor | White | 6500°K | 5050 | 60 | 5m | 5050-24-CW-60-5-20-1 |
| | Natural White | 24 | Indoor | White | 4100°K | 5050 | 60 | 5m | 5050-24-NW-60-5-20-1 |
| | Warm White | 24 | Indoor | White | 2700°K | 5050 | 60 | 5m | 5050-24-WW-60-5-20-1 |
| | RGB | 24 | Indoor | White | N/A | 5050 | 60 | 5m | 5050-24-RGB-60-5-20-1 |
| | RGB + Cool White | 24 | Indoor | White | N/A | 5050 | 60 | 5m | 5050-24-RGBCW-60-5-20-1 |
| | Adjustable White | 24 | Indoor | White | 2700°K - 6500°K | 3528 | 120 | 5m | 3528-24-WWCW-120-5-20-1 |
| | Cool White | 24 | Indoor | White | 6500°K | 3528 | 60 | 5m | 3528-24-CW-120-5-20-1 |
| | Warm White | 24 | Indoor | White | 2700°K | 3528 | 60 | 5m | 3528-24-WW-120-5-20-1 |

QolorFLEX LED Tape Specifications

24V LED Tapes: (Continued)

| | | | | | | | | | |
|------------|----------------------------|----|---------|-------|-----------------|------|-----|----|--------------------------------|
| | Quad Chip RGB + Amber | 24 | Indoor | White | N/A | 5050 | 60 | 5m | 5050-24-Q-RGBA-60-5-20-1 |
| NEW | Quad Chip RGB + Cool White | 24 | Indoor | White | 6500°K | 5050 | 60 | 5m | 5050-24-Q-RGBCW-60-5-20-1 |
| | Quad Chip RGB + Indigo | 24 | Indoor | White | N/A | 5050 | 60 | 5m | 5050-24-Q-RGBI-60-5-20-1 |
| | Quad Chip RGB + Warm White | 24 | Indoor | White | 2700°K | 5050 | 60 | 5m | 5050-24-Q-RGBWW-60-5-20-1 |
| | 5-in-1 RGB + Amber + CW | 24 | Indoor | White | N/A | 5050 | 60 | 5m | 5050-24-RGBACW-60-5-20-1 |
| NEW | 5-in-1 HiQ High CRI | 24 | Indoor | White | N/A | 5050 | 60 | 5m | 5050-24-RGBH27006500-60-5-20-1 |
| | Cool White | 24 | Outdoor | White | 6500°K | 5050 | 60 | 5m | 5050-24-CW-60-5-67-1 |
| | Natural White | 24 | Outdoor | White | 4100°K | 5050 | 60 | 5m | 5050-24-NW-60-5-67-1 |
| | Warm White | 24 | Outdoor | White | 2700°K | 5050 | 60 | 5m | 5050-24-WW-60-5-67-1 |
| | Adjustable White | 24 | Outdoor | White | 2700°K - 6500°K | 3528 | 120 | 5m | 3528-24-WWCW-120-5-67-1 |
| | RGB | 24 | Outdoor | White | N/A | 5050 | 60 | 5m | 5050-24-RGB-60-5-67-1 |

12V LED Tapes:

| NAME | VOLTAGE | USE | BACKING COLOR | COLOR TEMP | LED SIZE | LEDs/M | LENGTH | PART NUMBER |
|---------------------|---------|---------|---------------|------------|----------|--------|--------|-------------------------|
| Cool White | 12 | Indoor | White | 6500°K | 5050 | 60 | 5m | 5050-12-CW-60-5-20-1 |
| Cool White | 12 | Indoor | White | 6500°K | 5050 | 30 | 5m | 5050-12-CW-30-5-20-1 |
| Cool White | 12 | Indoor | White | 6500°K | 3528 | 60 | 5m | 3528-12-CW-60-5-20-1 |
| Cool White | 12 | Indoor | White | 6500°K | 3528 | 30 | 5m | 3528-12-CW-30-5-20-1 |
| Natural White | 12 | Indoor | White | 4100°K | 5050 | 60 | 5m | 5050-12-NW-60-5-20-1 |
| Natural White | 12 | Indoor | White | 4100°K | 5050 | 30 | 5m | 5050-12-NW-30-5-20-1 |
| Natural White | 12 | Indoor | White | 4100°K | 3528 | 60 | 5m | 3528-12-NW-60-5-20-1 |
| Natural White | 12 | Indoor | White | 4100°K | 3528 | 30 | 5m | 3528-12-NW-30-5-20-1 |
| Warm White | 12 | Indoor | White | 2700°K | 5050 | 60 | 5m | 5050-12-WW-60-5-20-1 |
| Warm White | 12 | Indoor | White | 2700°K | 5050 | 30 | 5m | 5050-12-WW-30-5-20-1 |
| Warm White | 12 | Indoor | White | 2700°K | 3528 | 60 | 5m | 3528-12-WW-60-5-20-1 |
| Warm White | 12 | Indoor | White | 2700°K | 3528 | 30 | 5m | 3528-12-WW-30-5-20-1 |
| RGB | 12 | Indoor | White | N/A | 5050 | 60 | 5m | 5050-12-RGB-60-5-20-1 |
| RGB + Amber | 12 | Indoor | White | N/A | 5050 | 60 | 5m | 5050-12-RGBA-60-5-20-1 |
| RGB + Cool White | 12 | Indoor | White | 6500°K | 5050 | 60 | 5m | 5050-12-RGBCW-60-5-20-1 |
| RGB + Natural White | 12 | Indoor | White | 4100°K | 5050 | 60 | 5m | 5050-12-RGBNW-60-5-20-1 |
| RGB + Warm White | 12 | Indoor | White | 2700°K | 5050 | 60 | 5m | 5050-12-RGBWW-60-5-20-1 |
| RGB + Indigo | 12 | Indoor | White | N/A | 5050 | 60 | 5m | 5050-12-RGBI-60-5-20-1 |
| Cool White | 12 | Outdoor | White | 6500°K | 5050 | 60 | 5m | 5050-12-CW-60-5-67-1 |
| Natural White | 12 | Outdoor | White | 4100°K | 5050 | 60 | 5m | 5050-12-NW-60-5-67-1 |
| Warm White | 12 | Outdoor | White | 2700°K | 5050 | 60 | 5m | 5050-12-WW-60-5-67-1 |
| RGB | 12 | Outdoor | White | N/A | 5050 | 60 | 5m | 5050-12-RGB-60-5-67-1 |
| RGB + Amber | 12 | Outdoor | White | N/A | 5050 | 60 | 5m | 5050-12-RGBA-60-5-67-1 |

QolorFLEX NuNeon



QolorFLEX NuNeon at Super Bowl LV Halftime Show feat The Weeknd

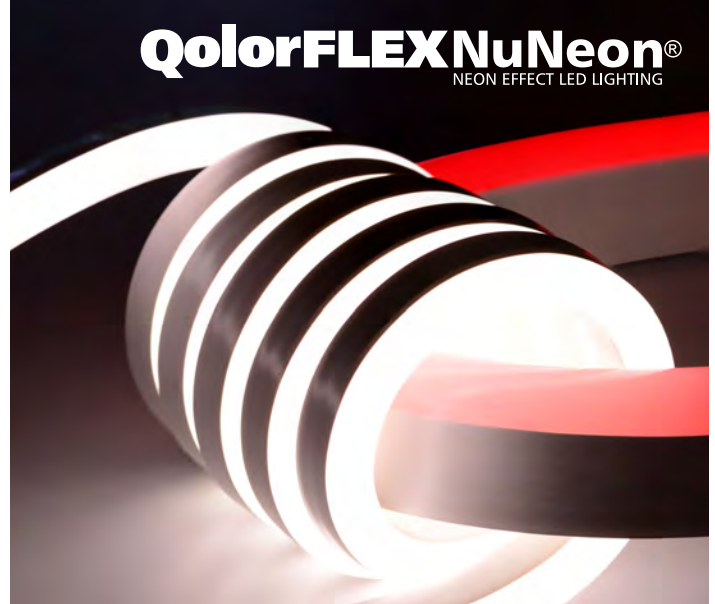

QolorFLEX NuNeon: Extremely Flexible and Bright

QolorFLEX NuNeon is an incredibly flexible and bright sealed LED linear lighting product that can be used to replace traditional neon lighting in entertainment and architectural projects. It was carefully developed to provide lighting and scenic designers with bold and bright accents for their designs. Each tape has a 12mm (1/2") minimum bending radius, making QolorFLEX NuNeon up to 80% more flexible than similar products on the market today. QolorFLEX NuNeon tape is available in nine vivid colors, including Tunable White HiQ High CRI for film and video projects, RGB, three types of white, and four solid colors. It is IP67 rated for indoor or outdoor use.

QolorFLEX NuNeon can be cut in 50mm (2") increments, and includes 200mm (8") cables on both ends for easy connections. QolorFLEX NuNeon operates on 24VDC and can be powered and controlled by variety of QolorFLEX Dimmers and power supplies.

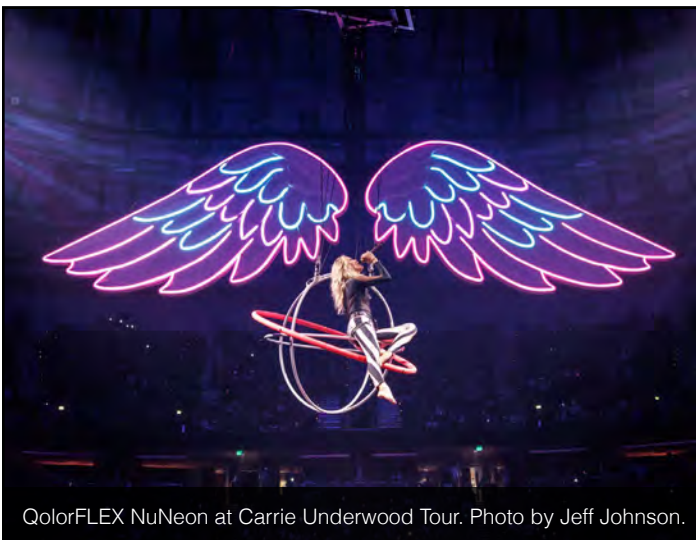
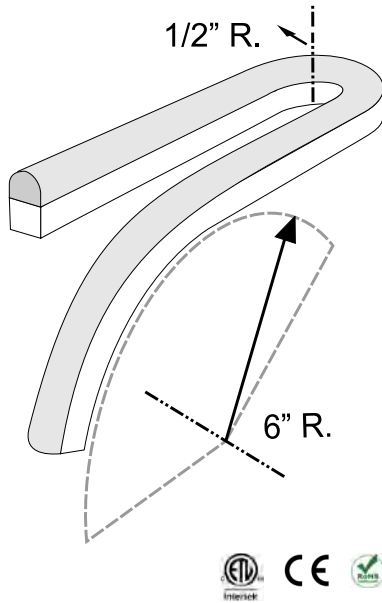
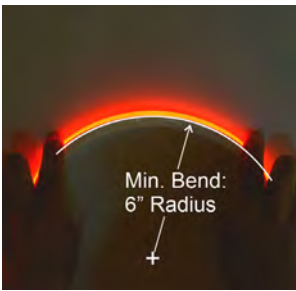

QolorFLEX NuNeon at Carrie Underwood Tour. Photo by Jeff Johnson.

“I think it all came together so well due to the versatility of QolorFLEX NuNeon as a low profile, highly flexible, super vibrant LED product backed by the team at City Theatrical.”

- Jay Woods, Technical Designer for Scenic Electrics, PRG ([Read the Carrie Underwood “Denim and Rhinestones” Tour case study](#))

QolorFLEX NuNeon Specifications

| PART NUMBER | NAME | VOLTAGE | COLOR TEMP | WAVELENGTH | POWER CONSUMPTION | LENGTH |
|-----------------------------|--|---------|----------------|----------------|-------------------|--------|
| NEW N914-H27006500-5 | QolorFLEX NuNeon, Tunable White HiQ High CRI | 24 | 2700°K, 6500°K | N/A | 70 w/5m (1 reel) | 5m |
| N914-CW-10 | QolorFLEX NuNeon, Cool White | 24 | 6500°K | N/A | 72w/10m (1 reel) | 10m |
| N914-NW-10 | QolorFLEX NuNeon, Natural White | 24 | 4000°K | N/A | 72w/10m (1 reel) | 10m |
| N914-WW-10 | QolorFLEX NuNeon, Warm White | 24 | 2700°K | N/A | 72w/10m (1 reel) | 10m |
| N914-A-10 | QolorFLEX NuNeon, Amber | 24 | N/A | 588 nm | 72w/10m (1 reel) | 10m |
| N914-B-10 | QolorFLEX NuNeon, Blue | 24 | N/A | 468 nm | 72w/10m (1 reel) | 10m |
| N914-G-10 | QolorFLEX NuNeon, Green | 24 | N/A | 518 nm | 72w/10m (1 reel) | 10m |
| N914-R-10 | QolorFLEX NuNeon, Red | 24 | N/A | 622 nm | 72w/10m (1 reel) | 10m |
| N914-RGB-5 | QolorFLEX NuNeon, RGB | 24 | N/A | 622/518/468 nm | 48 w/5m (1 reel) | 5m |

QolorFLEX NuNeon Accessories



| PART NUMBER | NAME | PART NUMBER | NAME |
|-------------|--|-------------|---|
| N914-01 | QolorFLEX NuNeon End Cap with Strain Relief, Pack of 10 | N914-05 | QolorFLEX NuNeon Aluminum Extrusion, 2m |
| N914-02 | QolorFLEX NuNeon End Cap, Pack of 10 | N914-07 | QolorFLEX NuNeon Aluminum Extrusion Mounting Clip, Pack of 10 |
| N914-03 | QolorFLEX NuNeon Lead Wire, Two Wire, 40cm | N914-09 | QolorFLEX NuNeon Plastic Mounting Clip, 30mm, Pack of 10 |
| N914-03-100 | QolorFLEX NuNeon Lead Wire, Two Wire, 40cm (not pictured) | NU1040 | QolorFLEX NuNeon Silicone, White |
| N914-04 | QolorFLEX NuNeon Lead Wire, Four Wire, 40cm | NU1034 | QolorFLEX NuNeon Heat Shrink Tubing, Clear, 2 feet (0.6m) |
| N914-04-100 | QolorFLEX NuNeon Lead Wire, Four Wire, 40cm (not pictured) | | |

Learn more about working with QolorFLEX NuNeon at: youtu.be/ti4ecRmyCMQ



QolorPIX Pixel Controlled LED Tape



QolorPIX Is Pixel Control Made Simple.

While many products on the market offer control of addressable LED tape and fixtures, the process of set up and operation can be challenging. Each QolorPIX Tape Controller is pre-configured with personality profiles that can be combined and adjusted quickly and easily to produce thousands of effects using QolorPIX Pixel Controlled LED Tape, including chases, fades, scrolls, bursts, and more.



Visualize and create plug & play effects with QolorPIX at: youtu.be/FaXkXH3QCrA

QolorPIX Pixel Controlled LED Tape

Part Number: Q5050-5-RGB-48-5-67-2



QolorPIX Pixel Controlled LED Tape is designed for the most demanding professional applications, with 48 individually controlled LED lights per meter. Each reel of tape includes a soldered-on four-pin XLR connector on one end, creating a plug and play connection to the QolorPIX Tape Controller. QolorPIX Pixel Controlled LED Tape runs on low voltage (5VDC) and is sold in five meter reels, with a maximum cable connection length (between controller and tape) of 10 meters. The tape is encased in clear rectangular silicone, making it water resistant (IP 67 rated) for indoor or outdoor use.

SPECIFICATIONS



| | |
|----------------------------|-----------------------------------|
| Part Number | Q5050-5-RGB-48-5-67-2 |
| LEDs per meter | 48 |
| Voltage | 5VDC |
| Watts/meter (max) | 14.4W |
| Viewing angle | 120° |
| PCB color (backing) | Black |
| IP Rating | 67 |
| Coating | Clear Silicone |
| Connection | 4-Pin XLRM soldered to 6" pigtail |
| Cutting increment | 0.827" (21mm) |
| Height | 0.188" (4.8mm) |
| Width | 0.563" (14.3mm) |
| Length | 16.4' (5m) |

QolorPIX Tape Controller, Eight Output



The QolorPIX Tape Controller offers eight ports, each accommodating five meters of pixel tape. It has a user-friendly control interface that allows the user to change mode, pixel length, dimmer, personality start address, and direction. It features an integrated power supply, a test function, and flicker finder for easy troubleshooting. It also offers wireless DMX control using Multiverse wireless DMX/RDM technology.

SPECIFICATIONS

| | |
|--|------------------------------|
| Part Number | 5850 |
| Number of outputs | 8 |
| Max LEDs per output | 240 |
| Voltage | 85-264 VAC |
| Watts (total output) | 600W |
| Max cable distance to LED strip | 10m (32.8 feet) |
| Output connectors | 4-Pin XLRF |
| Input power connection | PowerCON |
| DMX connections: | 5-Pin XLR |
| Compliance | ETL, CE, RoHS, FCC |
| Construction | NEMA 1 IP 20 steel enclosure |

QolorPIX Accessories

| PART NUMBER | NAME |
|-------------|---|
| 5840 | Power Cord, N5-15P to powerCON TRUE1 12 AWG 8' |
| 5870 | QolorPIX Rack Mount/ Pipe Mount Ears |
| 5729 | 2dBi Omni , Indoor 2.3" |
| 5891 | Four Pin XLRM with Three Conductor, 6" Tail |

| PART NUMBER | NAME |
|-------------|--|
| 6670 | Mounting Clip Kit with Screws (for one roll of QolorPIX Pixel Controlled LED Tape) |
| 6691 | QolorPIX Aluminum Extrusion, 2m 21mm W x 9mm H <i>(Image represents both 6691 and 6696)</i> |
| 6696 | QolorPIX Diffuser for 6691 Extrusion, 2m |
| 6692 | QolorPIX Aluminum Extrusion, 2m 21mm W x 14mm H <i>(Image represents both 6692 and 6697)</i> |
| 6697 | QolorPIX Diffuser for 6692 Extrusion, 2m |

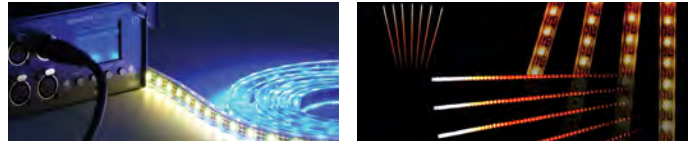

“QolorPIX solved many of our challenges – weather, controller distance, brightness – with a single, off-the-shelf solution.”

- Robert Kodadek, Co-Founder & Executive Creative Director, RMRK
([Read the Vince Lombardi Trophy Replica case study](#))

QolorFLEX Dimmers

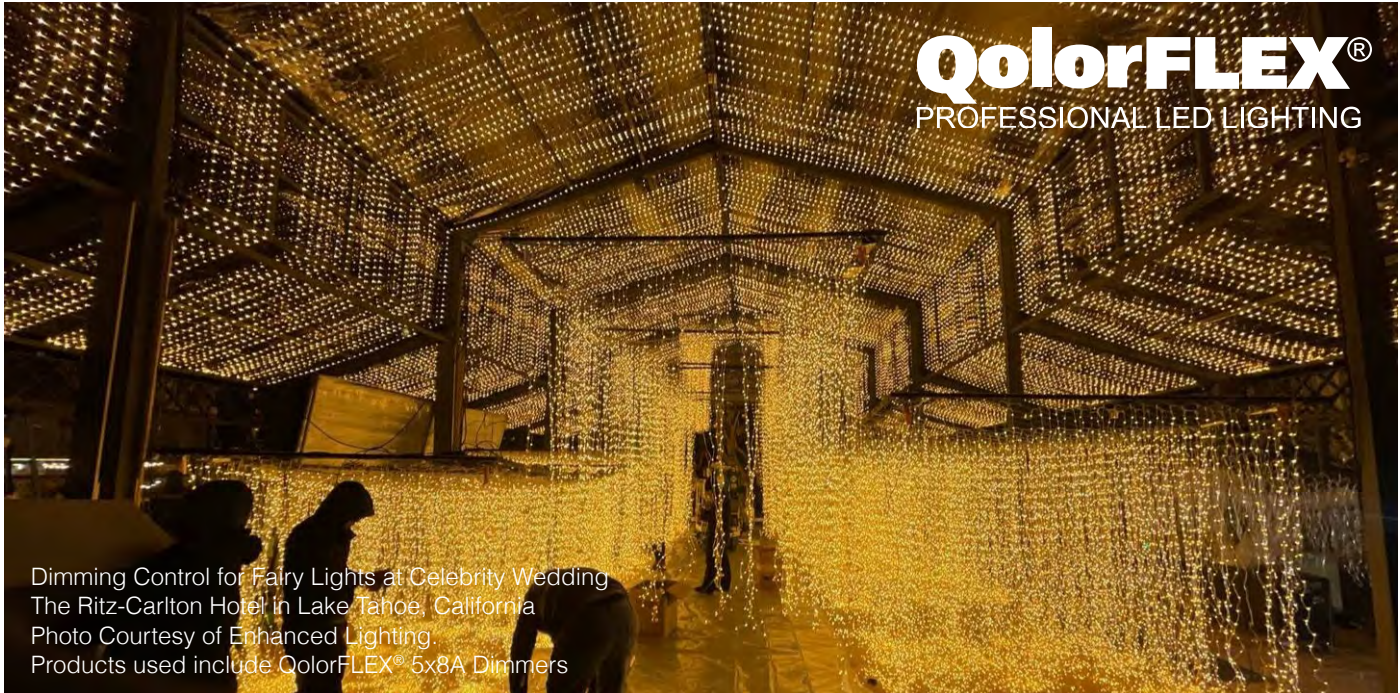

Dimming Control for Fairy Lights at Celebrity Wedding
The Ritz-Carlton Hotel in Lake Tahoe, California
Photo Courtesy of Enhanced Lighting
Products used include QolorFLEX® 5x8A Dimmers

QolorFLEX LED Dimmers pair perfectly with QolorFLEX LED Tape. All QolorFLEX Dimmers (seven wired and four wireless) are RDM capable, deliver ultra smooth, flicker-free PWM dimming, and are available in two, three, four, five, six, and twenty four channel models.

Our QolorFLEX 5x8A Dimmer, as an example, pairs perfectly with QolorFLEX 5-in-1 LED Tape. Several mounting styles are available to work with different installation requirements. QolorFLEX accessories, like wire, connectors, extrusions, and power supplies are available.

“QolorFLEX 5x8A Dimmers were the perfect solution for this installation. They provided a beautiful dimming curve and worked flawlessly.”

- John Woods, Principal Lighting and Audio Visual Specialist, Enhanced Lighting
([Read the Lake Tahoe wedding case study](#))



QolorFLEX 5x8A Dimmer

Part Number: 5809



The QolorFLEX 5x8A Dimmer can control a full 40A of LED tape spread over five channels of 8A each. This allows the control of 5-in-1 LED tape and unique combinations, such as RGB tape (three channels) and bi-color tape (two channels), or RGBX tape (four channels) and a single color tape (one channel) together in one unit. QolorFLEX 5x8A Dimmers use constant voltage technology to ensure consistent full range dimming, which is especially important at low end light levels. An easy to read onboard display and four button user interface allows selection of stand alone mode or setting DMX addresses, setting quantity of DMX channels, selecting 8 or 16 bit output resolution, setting PWM frequency (500Hz to 30KHz), setting output dimming curve values for matching the dimming curves of other dimmers in use, and setting the device's operating profile. QolorFLEX 5x8A Dimmers are also RDM capable. The unit requires a separate power supply providing input voltage of 12 or 24VDC to match the LED tape you are using. The maximum current load per channel is 8A with a maximum device output of 40A.

QolorFLEX 4x5A Dimmer

Part Number: 5821

The QolorFLEX 4x5A Dimmer can control a full 20A of LED tape spread over four channels of 5A each. It uses constant voltage technology which ensures consistent full range dimming that is especially important at low end light levels. The unit is easily surface mounted and has spring contact terminal blocks for all electrical and data connections. An easy to read onboard display and four button user interface allows selection of stand alone mode or setting DMX addresses, setting quantity of DMX channels, selecting 8 or 16 bit output resolution, setting PWM frequency (500Hz to 30KHz), setting output dimming curve values for matching the dimming curves of other dimmers in use, and setting the device's operating profile. The QolorFLEX 4x5A Dimmer is also RDM capable. The unit requires a separate power supply providing input voltage of 12 or 24VDC to match the LED tape you are using. The maximum current load per channel is 5A with a maximum device output of 20A.



QolorFLEX 24x3A Dimmer

Part Number: 5810

The QolorFLEX 24x3A Dimmer features twenty four channels of control and is suited for larger installations like retail spaces, or architectural illumination. It is compatible with 12V and 24V single color and multi-color LED tapes. It can be operated with a standard DMX color controller, or as a stand alone device using one of its pre-programmed color changing modes.



QolorFLEX 25x3A Dimmer

Part Number: 5811

The QolorFLEX 25x3A Dimmer features 25 channels of control and can accommodate five-channel LED tapes easily, to create efficiencies when it comes to installation time and wiring. This dimmer is fully DMX and RDM compatible and offers standalone functions. It is the five-channel version of City Theatrical's QolorFLEX 24x3A Dimmer (P/N 5810), for users who seek high-capacity dimmers to use for installations of 5-in-1 LED tapes, rather than four- or fewer channel LED tapes. The QolorFLEX 25x3A Dimmer's maximum current load per channel is 3A with a Maximum Device Input of 75A.



QolorFLEX 4x5A DINrail Dimmer

Part Number: 5825



QolorFLEX 4x5A DINrail RJ45 Dimmer

Part Number: 5823

The QolorFLEX 4x5A DINrail Dimmers can control a full 20A of LED tape spread over four channels of 5A each. They use constant voltage technology which ensures consistent full range dimming that is especially important at low end light levels. Both units mount to a standard hat section DIN rail. Model 5823 features two RJ45 connectors for DMX communication plus spring contact terminals for power and output connections. Model 5825 has spring contact terminals for all connections.



Both feature easy to read onboard displays and four button user interface for setting DMX addresses, setting quantity of DMX channels, selecting 8 or 16 bit output resolution, setting PWM frequency (500Hz to 30KHz), setting output dimming curve values for matching the dimming curves of other dimmers in use, and setting the devices operating profile. Both units are RDM capable. Each unit requires a separate power supply providing input voltage of 12 or 24VDC to match the LED tape you are using. The maximum current load per channel is 5A with a maximum device output of 20A.

QolorFLEX Architectural LED PS/Driver Series

Part Number: 5758

QolorFLEX Architectural LED PS/Drivers provide a powerful and affordable way to power and control LED tape or other

LEDs in a permanent NEMA enclosure. They offer user selectable PWM dimming that is guaranteed not to flicker on camera which can be critical for those meeting areas where video or film image recording is in use for teleconferencing or any newsworthy event.

The drivers are ETL listed and CE certified, and feature DMX and 0-10V input control, an Integrated Power Supply AC to DC, and Four Class 2 rated dimmable circuits.

The drivers come in a rugged compact NEMA 1 steel enclosure with holes for wall mounting, electrical knockouts, and screw terminal connections. All models are made to order, with other configurations available.



QolorFLEX 2x2.5A Multiverse Dimmer

| P/N | Frequency | Universes |
|------|-----------|-----------|
| 5916 | 2.4GHz | 1 |
| 5917 | 900MHz | 1 |

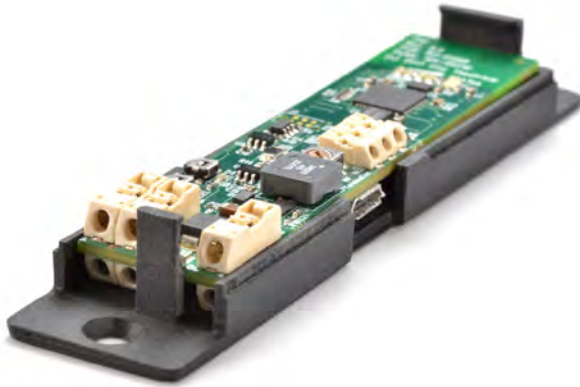

QolorFLEX® 2x2.5A Multiverse® Dimmers are small, constant voltage, two-output dimmers designed to be mounted in small spaces such as props, costumes, wands, and candles.

These dimmers can be controlled wirelessly using City Theatrical's Multiverse or SHoW DMX Neo wireless DMX/RDM technology, or with wired DMX. Each dimmer provides 20-bit PWM resolution and four DMX personality options (two variations of 8-bit and 16-bit control) for extremely smooth dimming at the low end of the dimming curve. Configuration is performed using RDM, such as with a City Theatrical DMXcat®, or with City Theatrical's USB Configuration program for PC or Mac.

A plastic case is included with each QolorFLEX 2x2.5A Multiverse Dimmer to allow easy mounting to scenery while enabling removal of the dimmer from the case for wiring and configuration. These dimmers are designed and built in the USA by City Theatrical.

Designed for Props,
Costumes, Wands,
and Candles



QolorFLEX®
PROFESSIONAL LED LIGHTING

Key Features

- Ideal for props and costumes with a low profile
- Supports ANSI E1.11 DMX512-A
- Compatible with all Multiverse and SHoW DMX transmitters
- Low profile latch connections for power, dimmer outputs, and DMX out
- Output port test buttons
- Configuration set via RDM or with City Theatrical's USB Configuration Program for PC or Mac.
- Built-in short circuit, reverse polarity, and over temperature protection

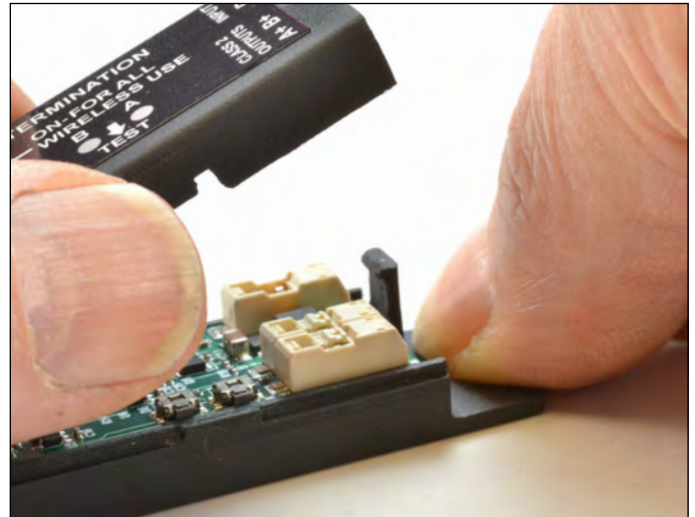

QolorFLEX 5x2.5A Multiverse Dimmer

| P/N | Frequency | Universes |
|------|---------------|-----------|
| 5942 | 900MHz/2.4GHz | 1 |
| 5943 | 2.4GHz | 1 |



QolorFLEX® 5x2.5A Multiverse® Dimmers are constant voltage, five-output dimmers that can be controlled wirelessly using City Theatrical's Multiverse wireless DMX/RDM technology, or legacy SHoW DMX Neo wireless DMX/RDM, or with wired DMX.

Each dimmer provides 20-bit PWM resolution and six DMX personality options (including: 8-bit (5ch), 16-bit (10ch), 8-bit Tunable White Single (2ch), 16-bit Tunable White Single (4ch), 8-bit Tunable White (4ch), and 16-bit Tunable White (8ch)) for extremely smooth dimming at the low end of the dimming curve. These dimmers use detachable input and output connectors to make wiring easy. Configuration is performed using RDM, such as with a City Theatrical DMXcat®, or with City Theatrical's USB Configuration program for PC/Mac. A mounting bracket is included with each dimmer to allow easy mounting to scenery. These dimmers are designed and built in the USA by City Theatrical, and pair perfectly with QolorFLEX 5-in-1 LED Tape for ideal use in props and costumes, or for areas where space is a concern.

Accessories for 5942/5943 Dimmers:

| PART NUMBER | NAME | |
|-------------|---|--|
| 5950 | XLR5M and XLR5F to Three Position Phoenix Connector, Female, 6" | |
| 5984 | Antenna, Omni, 900MHz/2.4GHz, 1.8dBi/3.8DbI Dual Band Stubby | |
| 5954 | Mounting Plate | |

**Constant Voltage,
Five-output, Wireless
DMX/RDM dimming**



QolorFLEX®
PROFESSIONAL LED LIGHTING

Key Features

- Wireless or wired DMX input
- Wired DMX output
- Mounting bracket included
- Compatible with all Multiverse and SHoW DMX Neo SHoW IDs
- User selectable choice of 2.4GHz or 900MHz radio (P/N 5942 only)
- DMX termination selector switch
- Per channel level indicator lights, PWM frequency, response time, curve selections, bump buttons with disable function, offsets to balance the point at which each dimmer first turns on (important for perfect low end balance)



| PART NUMBER | NAME | |
|-------------|---|--|
| 5951 | Phoenix Connector, Six Position, Female | |
| 5952 | Phoenix Connector, Three Position, Female | |
| 5668 | Phoenix Connector, Two Position, Female | |

QolorFLEX Dimmer Specifications









| Name | QolorFLEX 2x2.5A Multiverse Dimmer | QolorFLEX 4x5A Dimmer | QolorFLEX 4x5A DINrail RJ45 Dimmer | QolorFLEX 4x5A DINrail Dimmer |
|-------------------------------|--|---|---|---|
| Part Number | 5916 (2.4GHz), 5917 (900MHz) | 5821 | 5823 | 5825 |
| Output Channels | 2 | Selectable, 1 to 4 | 4 | 4 |
| Input Voltage | 6-30VDC | 12 to 36VDC 20A | 12~24VDC | 12~24VDC |
| Max Output per Channel | 0.9A @12V | 5A | 5A | 5A |
| Max Device Output | 1.8A | 20A@12V | 20A | 20A |
| Size L x W x H | 3.187" x 0.7" x 0.5" (81 x 18.8 x 12mm) | 2.1" x 6.7" x 1.1" (53.4 x 170 x 28mm) | 2.1" x 6.7" x 1.1" (53.4 x 110 x 65mm) | 2.1" x 4.32" x 2.56" (53.4 x 110 x 65mm) |
| Weight | 0.32 oz (9g) | 4.8 oz (0.14 kg) | 4 oz (0.11kg) | 4 oz. (0.11 kg) |
| Power Connections | Spring Terminals | Spring Terminals | Spring Terminals | Spring Terminals |
| Output Connections | Spring Terminals | Spring Terminals | Spring Terminals | Spring Terminals |
| DMX Connections | Spring Terminals | Spring Terminals | 2x RJ45 | Spring Terminals |
| 0-10V Connections | N/A | N/A | No | No |
| User Interface | RDM/USB | 4 Button, plus alpha/ numeric display | 4 button, plus alpha/ numeric display | 4 button, plus alpha/ numeric display |
| DMX Address | Yes | Yes | Yes | Yes |
| Curve Selection | Yes - 3 | Yes - 99 | Yes - 99 | Yes - 99 |
| Film & Video Modes | Yes - 5 | Yes - 18 | Yes - 18 | Yes - 18 |
| DMX Termination | N/A | No | No | No |
| SHoW ID | All Multiverse & Neo | No | N/A | N/A |
| Bump Buttons | Yes | No | No | No |
| Pilot Lights | Yes | Yes | Yes | Yes |
| Status Light | Yes | No | No | No |
| Smoothing Settings | Yes - Variable 6 | No | No | No |
| Stand Alone Levels | No | Yes | Yes | Yes |
| RDM | Yes | Yes | Yes | Yes |
| Compliance | 5916: CE, RoHS, FCC, AU, Japan, IC 5917: RoHS, FCC, IC | CE, RoHS | CE , RoHS | CE, RoHS |





| QolorFLEX 5x2.5A Multiverse Dimmer | QolorFLEX 5x8A Dimmer | QolorFLEX 24x3A Dimmer | QolorFLEX 25x3A Dimmer | QolorFLEX Architectural LED PS/Driver Series |
|---|--|--|--|---|
| 5942 (900MHz/2.4GHz), 5943 (2.4GHz) | 5809 | 5810 | 5811 | 5758 |
| 5 | 5 | 24 | 25 | 4 |
| 5-30VDC | 12~24VDC | 12~24VDC | 12~24VDC | 100V-277VAC |
| 4A | 8A | 3A | 3A | 3.3A |
| 12.5A | 40A | 72A | 75A | 10A |
| 5.63" x 2.75" x 0.63" (143 x 70 x 16mm) | 2.88" x 6.5" x 1.5" (73 x 165 x 38mm) | 10.24" x 4.72" x 1.57" (260 x 120 x 40mm) | 10.24" x 4.72" x 1.57" (260 x 120 x 40mm) | 10.5" x 16.15" x 3.56" (266mm x 410mm x 1mm) |
| 2.4 oz (70g) | 13.6 oz (0.39 kg) | 3 lbs. (1.36kg) | 3 lbs. (1.36kg) | 14.5 lbs. (6.58kg) |
| Pluggable connectors | Screw Terminals | Screw Terminals | 1 removable Terminal Block Connector (6614) | Hard wire terminals |
| Pluggable connectors | Screw Terminals | Screw Terminals | 5 removable Terminal Block Connectors (6613) | Hard wire terminals |
| Pluggable connectors | 5-Pin XLR, RJ-45, Screw Terminals | 5 Pin XLR, RJ-45 | etherCON RJ45 Connectors, 5-Pin XLR, and 3-Pin XLR | RJ-45 |
| N/A | No | No | No | User Selectable Sourcing or Sinking |
| RDM/USB | 4 button, plus alpha/ numeric display | 4 button, plus alpha/ numeric display | 4 recessed buttons, plus alpha/ numeric display | DIP Switches, BCD |
| Yes | Yes | Yes | Yes | Yes |
| Yes - 3 | Yes - 99 | Yes - 99 | Yes - 99 | Yes - 4 |
| Yes - 5 | Yes - 18 | Yes - 18 | Yes - 18 | Yes - 5 |
| N/A | No | No | No | Yes |
| All Multiverse & Neo | N/A | N/A | N/A | Yes |
| Yes | No | No | No | N/A |
| Yes | Yes | Yes | Yes | Yes |
| Yes | No | No | No | Yes |
| Yes - Variable 6 | No | No | No | Yes - 6 |
| No | Yes | Yes | Yes | No |
| Yes | Yes | Yes | Yes | Yes |
| 5942: RoHS, FCC, IC 5943: CE, RoHS, FCC, ACMA, ARIB, IC | CE, ROHS | CE, ROHS | CE, ROHS | ETL |

QolorFLEX LED Tape Accessories





Ribbon Cables:

| P/N | NAME | |
|---------|--|---|
| 6607 | Ribbon Cable, Six Conductor, 18 GA |  |
| 6607-20 | Ribbon Cable, Six Conductor, 20 GA (thinner than 18 GA) |  |
| 6600 | Ribbon Cable, Five Conductor, 18 GA |  |
| 6600-20 | Ribbon Cable, Five Conductor, 20 GA (thinner than 18 GA) |  |
| 6608 | Ribbon Cable, Four Conductor, 18 GA |  |
| 6606 | Ribbon Cable, Three Conductor, 18 GA |  |
| 6605 | Ribbon Cable, Two Conductor, 18 GA |  |













Connectors:

| P/N | NAME | |
|------|--|---|
| 6612 | Terminal Block Connector, Six Pin, Male |  |
| 6613 | Terminal Block Connector, Six Pin, Female |  |
| 6610 | Terminal Block Connector, Five Pin, Male |  |
| 6611 | Terminal Block Connector, Five Pin, Female |  |
| 5673 | Terminal Block Connector, Four Pin Male |  |
| 5674 | Terminal Block Connector, Four Pin Female |  |
| 5671 | Terminal Block Connector, Three Pin Male |  |
| 5672 | Terminal Block Connector, Three Pin Female |  |
| 5657 | Terminal Block Connector, 2-Pin Male |  |
| 5658 | Terminal Block Connector, 2-Pin Female |  |
| 6615 | Female barrel to screw terminal connector |  |
| 6616 | Male barrel to screw terminal connector |  |

Extrusions and Diffusers:

| P/N | NAME | |
|------|--|---|
| 6693 | Aluminum Extrusion, 45-Degree, 2m for 45-Degree LED Tape installations |  |
| 6694 | Diffuser for 45-Degree Extrusion, 2m |  |
| 6690 | Aluminum Extrusion, Low Profile, 2m |  |
| 6695 | Diffuser for Low Profile Extrusion, 2m |  |

End Caps, Tape, Clips, and More:

| P/N | NAME | |
|---------------|--|---|
| 6690-1 | End Cap for 6690 Aluminum Extrusion (Pack of 10) |  |
| 6690-2 | End Cap with hole for 6690 Extrusion (Pack of 10) |  |
| 6671-1 | End Cap for 6693 45-Deg Extrusion (Pack Of 10) | |
| 6671-2 | End Cap with hole for 6693 45-Deg Extrusion (Pack Of 10) |  |
| 6680 | Waterproof End Caps for Outdoor tapes (Packs of 10) 9mm w/ 2 holes |  |
| 6682 | 8mm (no holes) |  |
| 6684 | 12mm w/ 4 holes |  |
| 6686 | 12mm (no holes) |  |
| 6625 | 3M VHB Double Sided Tape Roll, 72 yards |  |
| 6630 | Outdoor Tape Clips and Screws (Pack of 12) |  |
| 6632 | Clips for 6693 45-Degree Extrusion (Metal) for LED Tape (Pack Of 12) |  |
| 5748 | QolorFLEX Connect 10. A time saving solution for managing the multiple wire runs and numerous connections needed for large scale installations of LED tape. |  |
| Call for info | QolorFLEX 24V Demo Kit. For easy side-by-side comparisons of our QolorFLEX 24V LED Tape products. Call 201.549.1160 to get started. |  |

CITY
THEATRICAL
NEW YORK • LONDON
An EnvironmentalLights Company

475 Barell Avenue, Carlstadt, NJ 07072 Office 31, Units 1-3, Beverley Way,
Phone: 800.230.9497 or 201.549.1160 New Malden, KT3 4PH U.K.
Fax: 201.549.1161 Phone: +44 (0) 20 8949 5051

© 2024 City Theatrical, LLC. Patents Pending.