

QolorFLEX®

PROFESSIONAL LED LIGHTING



CITY
THEATRICAL

NEW YORK • LONDON

An Environmental Lights Company

QolorFLEX® Quad Chip RGB Amber Plus Deep Red LED Tape

About QolorFLEX

City Theatrical's QolorFLEX® brand of LED Lighting is recognized for its superior quality, versatility, and variety. Created specifically for lighting professionals working in theatrical, television and film, and architectural applications, our goal was to produce a premium product line offering designers a variety of configurations of tape that could be incorporated into their projects easily. Backed by City Theatrical's superior technical expertise and support, QolorFLEX LED Tape is now used on hundreds of productions and in environments across the globe.

In addition to the original QolorFLEX LED Tape, the brand now includes a wide array of wired and wireless dimmers, our plug and play QolorPIX® Pixel Controlled LED Tape system, and QolorFLEX NuNeon® linear lighting and accessories – making it the professional's brand of choice for distinctive, dependable LED lighting products.



Learn more about QolorFLEX in the overview video at: <https://youtu.be/inPg3uOmpVo>

Ways You'll Benefit

High Quality Products That Work

QolorFLEX products are all professional grade, tested, and trusted. All LED tapes under the QolorFLEX brand are ETL listed and CE and RoHS compliant.



Maximum Creative Potential

We offer a complete line of tape, dimmers, accessories, and more so lighting and scenic designers can maximize their creative vision for a performance or installation.

Easy To Work With

QolorFLEX products are all installation friendly with a variety of mounting and wiring accessories available.

Long Lasting Performance

Our LED Tape products meet or exceed industry standards for service life.

Consistent Colour Matching

Our LEDs are binned to assure that your tape will always match if you buy several units together or replace one at a time.

Support When You Need It

The QolorFLEX line is backed by the support and knowhow of the City Theatrical team – the best in the business for over 35 years.

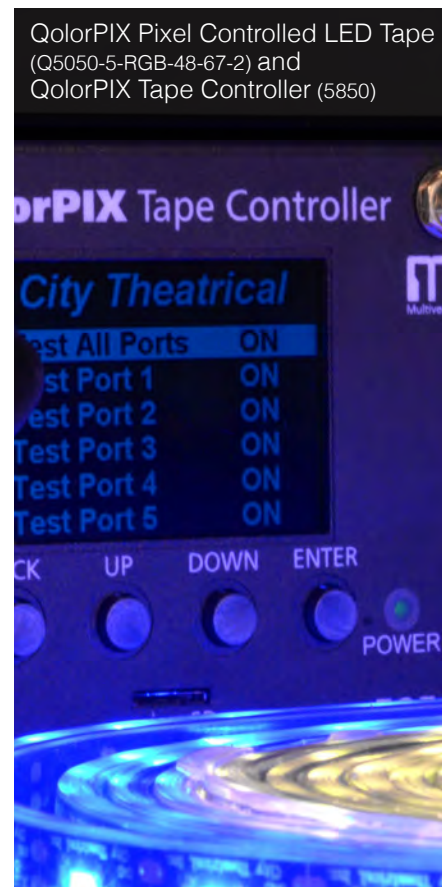

QolorFLEX LED Tapes: 40+ Varieties including HiQ High CRI

Professional Grade LED Linear Lighting

The QolorFLEX LED Tape line is complete with 40+ types of high quality tape to add to any designer's toolkit. All QolorFLEX LED Tape is ETL listed, and CE and RoHS compliant, and sold in five metre reels with six-inch pigtails soldered on both ends for easy connections to dimmers.

Available in 12 and 24 volt and indoor and outdoor configurations, our white tapes range in colour temperature from warm white, at 2700° K, to daylight, at 6500° K. We also offer an adjustable dual white for fine-tuning the colour balance, three and four colour tapes, like RGB and RGBA, to create thousands of colours, and five colour "5-in-1" tape for ultimate colour control. Additional QolorFLEX LED Tapes include HiQ High CRI for film and television, and 395 UV.

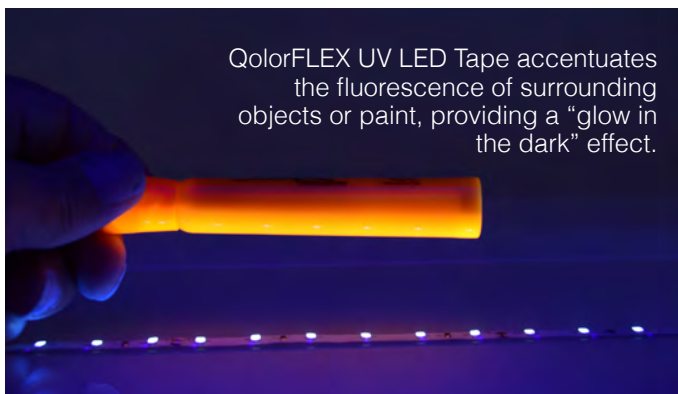

“We chose QolorFLEX because we knew it would give us the look and flexibility we were going for, and also because we’ve used it for other installations without having to replace it for years.”

- Mark Miskimen, President, ACME Corp.
Production Resources, Milwaukee, Wisconsin
([Read the Lakefront Brewery case study](#))

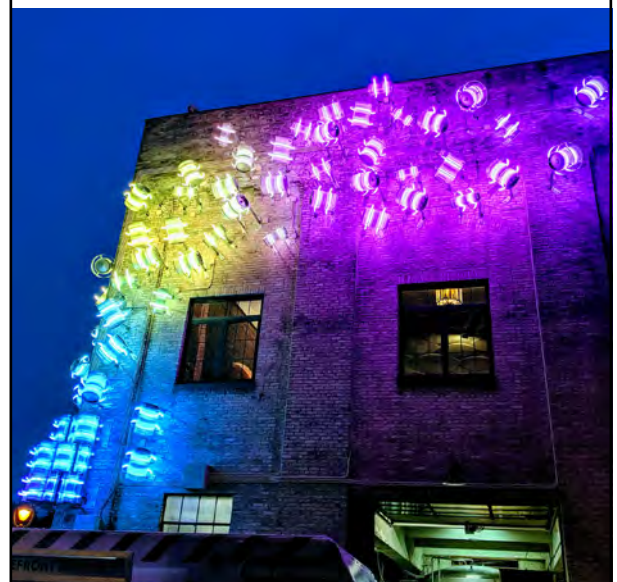

QolorFLEX LED Tape



City Theatrical's QolorFLEX brand of LED Lighting is recognized for its superior quality, versatility, and variety. Created specifically for lighting professionals working in theatrical, television and film, and architectural applications, our goal was to produce a premium product line offering designers a multitude of configurations that could be incorporated into their projects easily. Backed by City Theatrical's superior technical expertise and support, QolorFLEX LED Tape is now used for numerous productions and environments across the globe.

Sample Note:

To order 18" (45cm) samples of QolorFLEX LED Tape, change the Part Number length specifier to "0".

Example:
5050-12-NW-60-5-20-1

↑
Length (m)



QolorFLEX LED Tape Specifications

24V LED Tapes:

	NAME	VOLTAGE	USE	BACKING COLOUR	COLOUR TEMP	LED SIZE	LEDs/M	LENGTH	PART NUMBER
NEW	HiQ 3200°K	24	Indoor	White	3200°K	2835	120	5m	2835-24-H3200-120-5-20-1
NEW	HiQ 6000°K	24	Indoor	White	6000°K	2835	120	5m	2835-24-H6000-120-5-20-1
NEW	HiQ 2700-6500°K	24	Indoor	White	2700°K, 6500°K	3527	120	5m	3527-24-H27006500-120-5-20-1
NEW	UV	24	Indoor	White	N/A	2835	60	5m	835-24-UV395-60-5-20-1
	Cool White	24	Indoor	White	6500°K	5050	60	5m	5050-24-CW-60-5-20-1
	Natural White	24	Indoor	White	4100°K	5050	60	5m	5050-24-NW-60-5-20-1
	Warm White	24	Indoor	White	2700°K	5050	60	5m	5050-24-WW-60-5-20-1
	RGB	24	Indoor	White	N/A	5050	60	5m	5050-24-RGB-60-5-20-1
	RGB + Cool White	24	Indoor	White	N/A	5050	60	5m	5050-24-RGBCW-60-5-20-1
	Adjustable White	24	Indoor	White	2700°K - 6500°K	3528	120	5m	3528-24-WWCW-120-5-20-1
	Cool White	24	Indoor	White	6500°K	3528	60	5m	3528-24-CW-120-5-20-1
	Warm White	24	Indoor	White	2700°K	3528	60	5m	3528-24-WW-120-5-20-1

QolorFLEX LED Tape Specifications

24V LED Tapes: (Continued)

	Quad Chip RGB + Amber	24	Indoor	White	N/A	5050	60	5m	5050-24-Q-RGBA-60-5-20-1
NEW	Quad Chip RGB + Cool White	24	Indoor	White	6500°K	5050	60	5m	5050-24-Q-RGBCW-60-5-20-1
	Quad Chip RGB + Indigo	24	Indoor	White	N/A	5050	60	5m	5050-24-Q-RGBI-60-5-20-1
	Quad Chip RGB + Warm White	24	Indoor	White	2700°K	5050	60	5m	5050-24-Q-RGBWW-60-5-20-1
	5-in-1 RGB + Amber + CW	24	Indoor	White	N/A	5050	60	5m	5050-24-RGBACW-60-5-20-1
NEW	5-in-1 HiQ High CRI	24	Indoor	White	N/A	5050	60	5m	5050-24-RGBH27006500-60-5-20-1
	Cool White	24	Outdoor	White	6500°K	5050	60	5m	5050-24-CW-60-5-67-1
	Natural White	24	Outdoor	White	4100°K	5050	60	5m	5050-24-NW-60-5-67-1
	Warm White	24	Outdoor	White	2700°K	5050	60	5m	5050-24-WW-60-5-67-1
	Adjustable White	24	Outdoor	White	2700°K - 6500°K	3528	120	5m	3528-24-WWCW-120-5-67-1
	RGB	24	Outdoor	White	N/A	5050	60	5m	5050-24-RGB-60-5-67-1

12V LED Tapes:

NAME	VOLTAGE	USE	BACKING COLOUR	COLOUR TEMP	LED SIZE	LEDs/M	LENGTH	PART NUMBER
Cool White	12	Indoor	White	6500°K	5050	60	5m	5050-12-CW-60-5-20-1
Cool White	12	Indoor	White	6500°K	5050	30	5m	5050-12-CW-30-5-20-1
Cool White	12	Indoor	White	6500°K	3528	60	5m	3528-12-CW-60-5-20-1
Cool White	12	Indoor	White	6500°K	3528	30	5m	3528-12-CW-30-5-20-1
Natural White	12	Indoor	White	4100°K	5050	60	5m	5050-12-NW-60-5-20-1
Natural White	12	Indoor	White	4100°K	5050	30	5m	5050-12-NW-30-5-20-1
Natural White	12	Indoor	White	4100°K	3528	60	5m	3528-12-NW-60-5-20-1
Natural White	12	Indoor	White	4100°K	3528	30	5m	3528-12-NW-30-5-20-1
Warm White	12	Indoor	White	2700°K	5050	60	5m	5050-12-WW-60-5-20-1
Warm White	12	Indoor	White	2700°K	5050	30	5m	5050-12-WW-30-5-20-1
Warm White	12	Indoor	White	2700°K	3528	60	5m	3528-12-WW-60-5-20-1
Warm White	12	Indoor	White	2700°K	3528	30	5m	3528-12-WW-30-5-20-1
RGB	12	Indoor	White	N/A	5050	60	5m	5050-12-RGB-60-5-20-1
RGB + Amber	12	Indoor	White	N/A	5050	60	5m	5050-12-RGBA-60-5-20-1
RGB + Cool White	12	Indoor	White	6500°K	5050	60	5m	5050-12-RGBCW-60-5-20-1
RGB + Natural White	12	Indoor	White	4100°K	5050	60	5m	5050-12-RGBNW-60-5-20-1
RGB + Warm White	12	Indoor	White	2700°K	5050	60	5m	5050-12-RGBWW-60-5-20-1
RGB + Indigo	12	Indoor	White	N/A	5050	60	5m	5050-12-RGBI-60-5-20-1
Cool White	12	Outdoor	White	6500°K	5050	60	5m	5050-12-CW-60-5-67-1
Natural White	12	Outdoor	White	4100°K	5050	60	5m	5050-12-NW-60-5-67-1
Warm White	12	Outdoor	White	2700°K	5050	60	5m	5050-12-WW-60-5-67-1
RGB	12	Outdoor	White	N/A	5050	60	5m	5050-12-RGB-60-5-67-1
RGB + Amber	12	Outdoor	White	N/A	5050	60	5m	5050-12-RGBA-60-5-67-1

QolorFLEX NuNeon



QolorFLEX NuNeon at Super Bowl LV Halftime Show feat The Weeknd

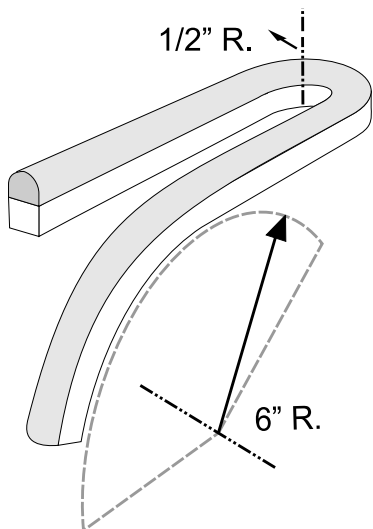
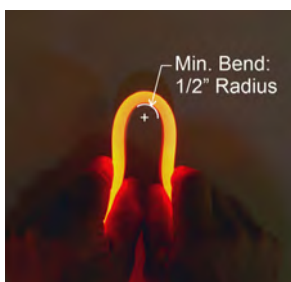
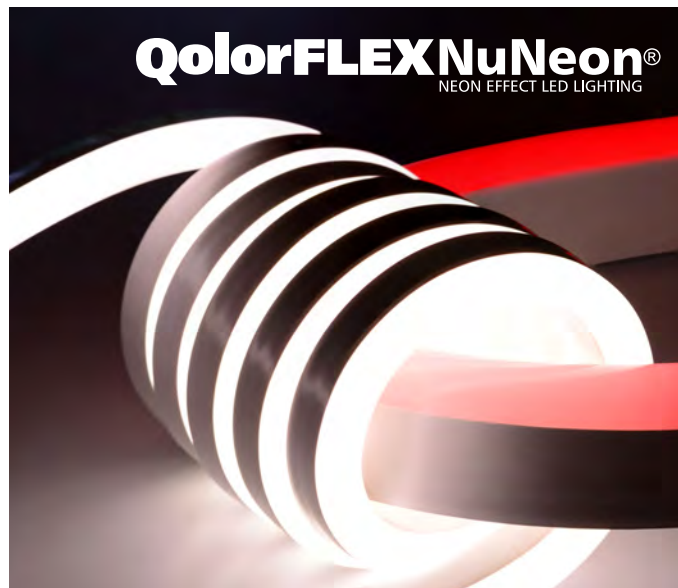

QolorFLEX NuNeon: Extremely Flexible and Bright

QolorFLEX NuNeon is an incredibly flexible and bright sealed LED linear lighting product that can be used to replace traditional neon lighting in entertainment and architectural projects. It was carefully developed to provide lighting and scenic designers with bold and bright accents for their designs. Each tape has a 12mm (1/2") minimum bending radius, making QolorFLEX NuNeon up to 80% more flexible than similar products on the market today. QolorFLEX NuNeon tape is available in nine vivid colours, including Tunable White HiQ High CRI for film and video projects, RGB, three types of white, and four solid colours. It is IP67 rated for indoor or outdoor use.

QolorFLEX NuNeon can be cut in 50mm (2") increments, and includes 200mm (8") cables on both ends for easy connections. QolorFLEX NuNeon operates on 24VDC and can be powered and controlled by variety of QolorFLEX Dimmers and power supplies.

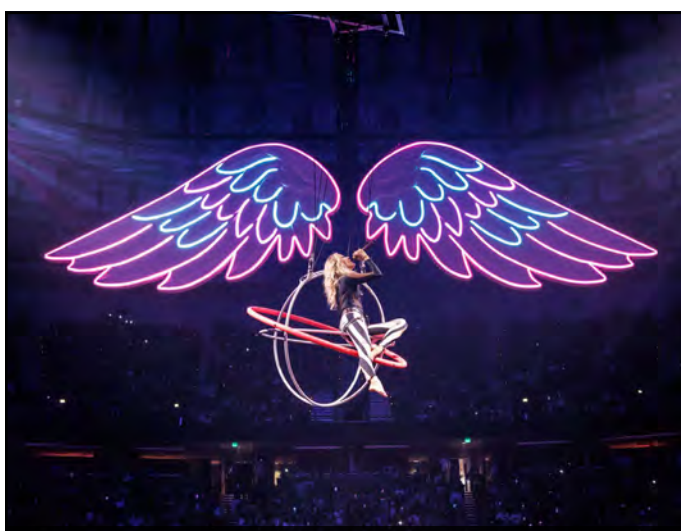









QolorFLEX NuNeon at Carrie Underwood Tour. Photo by Jeff Johnson.

“I think it all came together so well due to the versatility of QolorFLEX NuNeon as a low profile, highly flexible, super vibrant LED product backed by the team at City Theatrical.”

- Jay Woods, Technical Designer for Scenic Electrics, PRG ([Read the Carrie Underwood “Denim and Rhinestones” Tour case study](#))

QolorFLEX NuNeon Specifications

PART NUMBER	NAME	VOLTAGE	COLOUR TEMP	WAVELENGTH	POWER CONSUMPTION	LENGTH
NEW N914-H27006500-5	QolorFLEX NuNeon, Tunable White HiQ High CRI 	24	2700°K, 6500°K	N/A	70 w/5m (1 reel)	5m
N914-CW-10	QolorFLEX NuNeon, Cool White 	24	6500°K	N/A	72w/10m (1 reel)	10m
N914-NW-10	QolorFLEX NuNeon, Natural White 	24	4000°K	N/A	72w/10m (1 reel)	10m
N914-WW-10	QolorFLEX NuNeon, Warm White 	24	2700°K	N/A	72w/10m (1 reel)	10m
N914-A-10	QolorFLEX NuNeon, Amber 	24	N/A	588 nm	72w/10m (1 reel)	10m
N914-B-10	QolorFLEX NuNeon, Blue 	24	N/A	468 nm	72w/10m (1 reel)	10m
N914-G-10	QolorFLEX NuNeon, Green 	24	N/A	518 nm	72w/10m (1 reel)	10m
N914-R-10	QolorFLEX NuNeon, Red 	24	N/A	622 nm	72w/10m (1 reel)	10m
N914-RGB-5	QolorFLEX NuNeon, RGB 	24	N/A	622/518/468 nm	48 w/5m (1 reel)	5m

QolorFLEX NuNeon Accessories



PART NUMBER	NAME	PART NUMBER	NAME
N914-01	QolorFLEX NuNeon End Cap with Strain Relief, Pack of 10 	N914-05	QolorFLEX NuNeon Aluminum Extrusion, 2m 
N914-02	QolorFLEX NuNeon End Cap, Pack of 10 	N914-07	QolorFLEX NuNeon Aluminum Extrusion Mounting Clip, Pack of 10 
N914-03	QolorFLEX NuNeon Lead Wire, Two Wire, 40cm 	N914-09	QolorFLEX NuNeon Plastic Mounting Clip, 30mm, Pack of 10 
N914-03-100	QolorFLEX NuNeon Lead Wire, Two Wire, 40cm (not pictured)	NU1040	QolorFLEX NuNeon Silicone, White 
N914-04	QolorFLEX NuNeon Lead Wire, Four Wire, 40cm 	NU1034	QolorFLEX NuNeon Heat Shrink Tubing, Clear, 2 feet (0.6m) 
N914-04-100	QolorFLEX NuNeon Lead Wire, Four Wire, 40cm (not pictured)		

Learn more about working with QolorFLEX NuNeon at: youtu.be/ti4ecRmyCMQ



QolorPIX Pixel Controlled LED Tape



QolorPIX on *The Tonight Show Starring Jimmy Fallon*
Worn by host Jimmy Fallon and guest Jake Gyllenhaal
during "Brainstorm" segment

Designed by Kelly Hanson
Engineered and Constructed by Rachel Navarro
Photo by Andrew Lipovsky/NBCU Photo Bank via Getty Images

QolorPIX Is Pixel Control Made Simple.

While many products on the market offer control of addressable LED tape and fixtures, the process of set up and operation can be challenging. Each QolorPIX Tape Controller is pre-configured with personality profiles that can be combined and adjusted quickly and easily to produce thousands of effects using QolorPIX Pixel Controlled LED Tape, including chases, fades, scrolls, bursts, and more.



Visualize and create plug & play effects with QolorPIX at: youtu.be/FaXkXH3QCrA

QolorPIX Pixel Controlled LED Tape

Part Number: Q5050-5-RGB-48-5-67-2



QolorPIX Pixel Controlled LED Tape is designed for the most demanding professional applications, with 48 individually controlled LED lights per metre. Each reel of tape includes a soldered-on four-pin XLR connector on one end, creating a plug and play connection to the QolorPIX Tape Controller. QolorPIX Pixel Controlled LED Tape runs on low voltage (5VDC) and is sold in five metre reels, with a maximum cable connection length (between controller and tape) of 10 metres. The tape is encased in clear rectangular silicone, making it water resistant (IP 67 rated) for indoor or outdoor use.

SPECIFICATIONS



Part Number	Q5050-5-RGB-48-5-67-2
LEDs per metre	48
Voltage	5VDC
Watts/metre (max)	14.4W
Viewing angle	120°
PCB colour (backing)	Black
IP Rating	67
Coating	Clear Silicone
Connection	4-Pin XLRM soldered to 6" pigtail
Cutting increment	0.827" (21mm)
Height	0.188" (4.8mm)
Width	0.563" (14.3mm)
Length	16.4' (5m)

QolorPIX Tape Controller, Eight Output



The QolorPIX Tape Controller offers eight ports, each accommodating five metres of pixel tape. It has a user-friendly control interface that allows the user to change mode, pixel length, dimmer, personality start address, and direction. It features an integrated power supply, a test function, and flicker finder for easy troubleshooting. It also offers wireless DMX control using Multiverse wireless DMX/RDM technology.

SPECIFICATIONS

Part Number	5850
Number of outputs	8
Max LEDs per output	240
Voltage	85-264 VAC
Watts (total output)	600W
Max cable distance to LED strip	10m (32.8 feet)
Output connectors	4-Pin XLR
Input power connection	PowerCON
DMX connections:	5-Pin XLR
Compliance	ETL, CE, RoHS, FCC
Construction	NEMA 1 IP 20 steel enclosure



QolorPIX Accessories

PART NUMBER	NAME
5840	Power Cord, N5-15P to powerCON TRUE1 12 AWG 8'
5870	QolorPIX Rack Mount/ Pipe Mount Ears
5729	2dBi Omni , Indoor 2.3"
5891	Four Pin XLRM with Three Conductor, 6" Tail



PART NUMBER	NAME
6670	Mounting Clip Kit with Screws (for one roll of QolorPIX Pixel Controlled LED Tape)
6691	QolorPIX Aluminum Extrusion, 2m 21mm W x 9mm H (Image represents both 6691 and 6696)
6696	QolorPIX Diffuser for 6691 Extrusion, 2m
6692	QolorPIX Aluminum Extrusion, 2m 21mm W x 14mm H (Image represents both 6692 and 6697)
6697	QolorPIX Diffuser for 6692 Extrusion, 2m

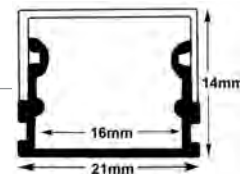
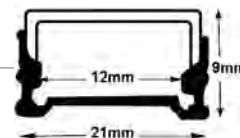

“QolorPIX solved many of our challenges – weather, controller distance, brightness – with a single, off-the-shelf solution.”

- Robert Kodadek, Co-Founder & Executive Creative Director, RMRK
[\(Read the Vince Lombardi Trophy Replica case study\)](#)

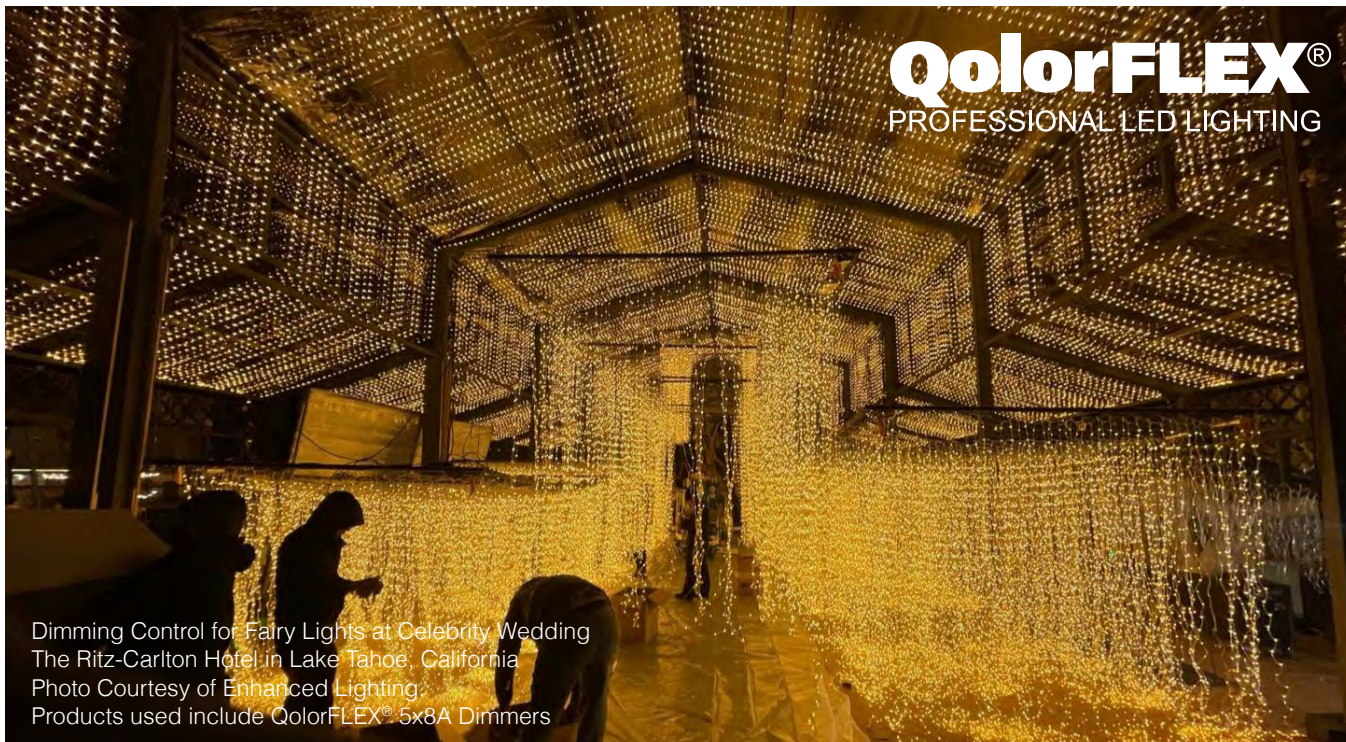

Dimming Control for Fairy Lights at Celebrity Wedding
The Ritz-Carlton Hotel in Lake Tahoe, California
Photo Courtesy of Enhanced Lighting
Products used include QolorFLEX® 5x8A Dimmers

QolorFLEX LED Dimmers pair perfectly with QolorFLEX LED Tape. All QolorFLEX Dimmers (seven wired and four wireless) are RDM capable, deliver ultra smooth, flicker-free PWM dimming, and are available in two, three, four, five, six, and twenty four channel models.

Our QolorFLEX 5x8A Dimmer, as an example, pairs

perfectly with QolorFLEX 5-in-1 LED Tape. Several mounting styles are available to work with different installation requirements. QolorFLEX accessories, like wire, connectors, extrusions, and power supplies are available.

“QolorFLEX 5x8A Dimmers were the perfect solution for this installation. They provided a beautiful dimming curve and worked flawlessly.”

- John Woods, Principal Lighting and Audio Visual Specialist, Enhanced Lighting
([Read the Lake Tahoe wedding case study](#))

QolorFLEX 5x8A Dimmer

Part Number: 5809

The QolorFLEX 5x8A Dimmer can control a full 40A of LED tape spread over five channels of 8A each. This allows the control of 5-in-1 LED tape and unique combinations, such as RGB tape (three channels) and bi-colour tape (two channels), or RGBX tape (four channels) and a single colour tape (one channel) together in one unit. QolorFLEX 5x8A Dimmers use constant voltage technology to ensure consistent full range dimming, which is especially important at low end light levels. An easy to read onboard display and four button user interface allows selection of stand alone mode or setting DMX addresses, setting quantity of DMX channels, selecting 8 or 16 bit output resolution, setting PWM frequency (500Hz to 30KHz), setting output dimming curve values for matching the dimming curves of other dimmers in use, and setting the device's operating profile. QolorFLEX 5x8A Dimmers are also RDM capable. The unit requires a separate power supply providing input voltage of 12 or 24VDC to match the LED tape you are using. The maximum current load per channel is 8A with a maximum device output of 40A.

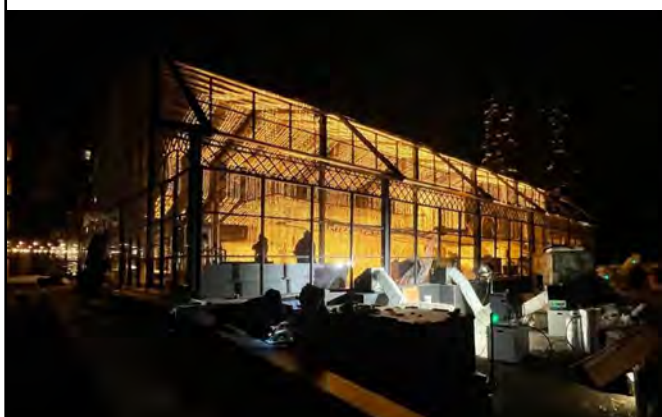

QolorFLEX 4x5A Dimmer

Part Number: 5821

The QolorFLEX 4x5A Dimmer can control a full 20A of LED tape spread over four channels of 5A each. It uses constant voltage technology which ensures consistent full range dimming that is especially important at low end light levels. The unit is easily surface mounted and has spring contact terminal blocks for all electrical and data connections. An easy to read onboard display and four button user interface allows selection of stand alone mode or setting DMX addresses, setting quantity of DMX channels, selecting 8 or 16 bit output resolution, setting PWM frequency (500Hz to 30KHz), setting output dimming curve values for matching the dimming curves of other dimmers in use, and setting the device's operating profile. The QolorFLEX 4x5A Dimmer is also RDM capable. The unit requires a separate power supply providing input voltage of 12 or 24VDC to match the LED tape you are using. The maximum current load per channel is 5A with a maximum device output of 20A.



QolorFLEX 24x3A Dimmer

Part Number: 5810

The QolorFLEX 24x3A Dimmer features twenty four channels of control and is suited for larger installations like retail spaces, or architectural illumination. It is compatible with 12V and 24V single colour and multi-colour LED tapes. It can be operated with a standard DMX colour controller, or as a stand alone device using one of its pre-programmed colour changing modes.



QolorFLEX 25x3A Dimmer

Part Number: 5811

The QolorFLEX 25x3A Dimmer features 25 channels of control and can accommodate five-channel LED tapes easily, to create efficiencies when it comes to installation time and wiring. This dimmer is fully DMX and RDM compatible and offers standalone functions. It is the five-channel version of City Theatrical's QolorFLEX 24x3A Dimmer (P/N 5810), for users who seek high-capacity dimmers to use for installations of 5-in-1 LED tapes, rather than four- or fewer channel LED tapes. The QolorFLEX 25x3A Dimmer's maximum current load per channel is 3A with a Maximum Device Input of 75A.



QolorFLEX 4x5A DINrail Dimmer

Part Number: 5825



QolorFLEX 4x5A DINrail RJ45 Dimmer

Part Number: 5823



The QolorFLEX 4x5A DINrail Dimmers can control a full 20A of LED tape spread over four channels of 5A each. They use constant voltage technology which ensures consistent full range dimming that is especially important at low end light levels. Both units mount to a standard hat section DIN rail. Model 5823 features two RJ45 connectors for DMX communication plus spring contact terminals for power and output connections. Model 5825 has spring contact terminals for all connections.

Both feature easy to read onboard displays and four button user interface for setting DMX addresses, setting quantity of DMX channels, selecting 8 or 16 bit output resolution, setting PWM frequency (500Hz to 30KHz), setting output dimming curve values for matching the dimming curves of other dimmers in use, and setting the devices operating profile. Both units are RDM capable. Each unit requires a separate power supply providing input voltage of 12 or 24VDC to match the LED tape you are using. The maximum current load per channel is 5A with a maximum device output of 20A.

QolorFLEX Architectural LED PS/Driver Series

Part Number: 5758

QolorFLEX Architectural LED PS/Drivers provide a powerful and affordable way to power and control LED tape or other LEDs in a permanent NEMA enclosure. They offer user selectable PWM dimming that is guaranteed not to flicker on camera which can be critical for those meeting areas where video or film image recording is in use for teleconferencing or any newsworthy event.



The drivers are ETL listed and CE certified, and feature DMX and 0-10V input control, an Integrated Power Supply AC to DC, and Four Class 2 rated dimmable circuits.

The drivers come in a rugged compact NEMA 1 steel enclosure with holes for wall mounting, electrical knockouts, and screw terminal connections. All models are made to order, with other configurations available.

QolorFLEX 2x2.5A Multiverse Dimmer

P/N	Frequency	Universes
5916	2.4GHz	1
5917	900MHz	1

Designed for Props,
Costumes, Wands,
and Candles



QolorFLEX®
PROFESSIONAL LED LIGHTING

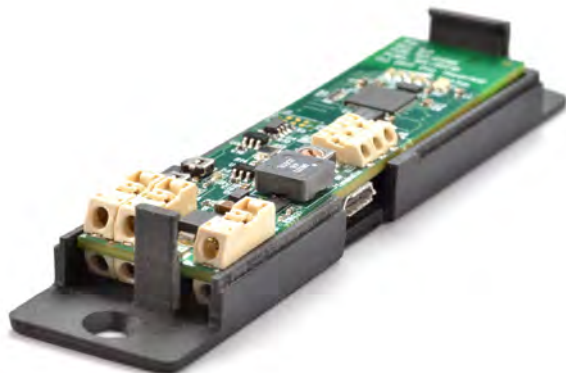

QolorFLEX® 2x2.5A Multiverse® Dimmers are small, constant voltage, two-output dimmers designed to be mounted in small spaces such as props, costumes, wands, and candles.

These dimmers can be controlled wirelessly using City Theatrical's Multiverse or SHoW DMX Neo wireless DMX/RDM technology, or with wired DMX. Each dimmer provides 20-bit PWM resolution and four DMX personality options (two variations of 8-bit and 16-bit control) for extremely smooth dimming at the low end of the dimming curve. Configuration is performed using RDM, such as with a City Theatrical DMXcat®, or with City Theatrical's USB Configuration program for PC or Mac.

A plastic case is included with each QolorFLEX 2x2.5A Multiverse Dimmer to allow easy mounting to scenery while enabling removal of the dimmer from the case for wiring and configuration. These dimmers are designed and built in the USA by City Theatrical.

Key Features

- Ideal for props and costumes with a low profile
- Supports ANSI E1.11 DMX512-A
- Compatible with all Multiverse and SHoW DMX transmitters
- Low profile latch connections for power, dimmer outputs, and DMX out
- Output port test buttons
- Configuration set via RDM or with City Theatrical's USB Configuration Program for PC or Mac.
- Built-in short circuit, reverse polarity, and over temperature protection

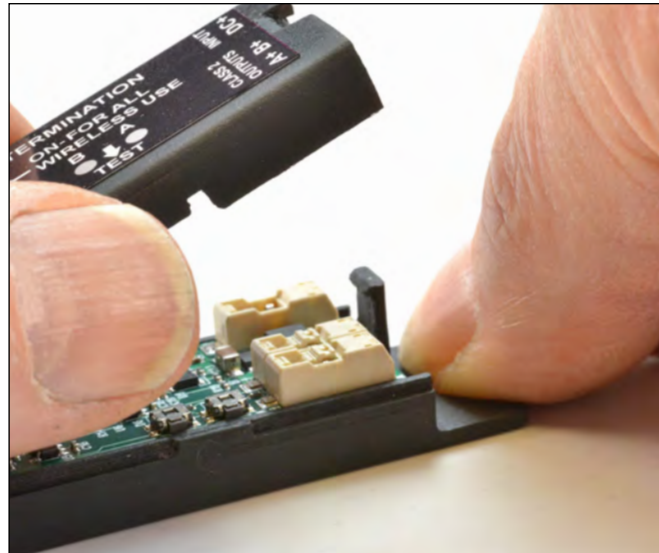

QolorFLEX 5x2.5A Multiverse Dimmer

P/N	Frequency	Universes
5942	900MHz/ 2.4GHz	1
5943	2.4GHz	1



QolorFLEX® 5x2.5A Multiverse® Dimmers are constant voltage, five-output dimmers that can be controlled wirelessly using City Theatrical's Multiverse wireless DMX/RDM technology, or legacy SHoW DMX Neo wireless DMX/RDM, or with wired DMX.

Each dimmer provides 20-bit PWM resolution and six DMX personality options (including: 8-bit (5ch), 16-bit (10ch), 8-bit Tunable White Single (2ch), 16-bit Tunable White Single (4ch), 8-bit Tunable White (4ch), and 16-bit Tunable White (8ch)) for extremely smooth dimming at the low end of the dimming curve. These dimmers use detachable input and output connectors to make wiring easy. Configuration is performed using RDM, such as with a City Theatrical DMXcat®, or with City Theatrical's USB Configuration program for PC/Mac. A mounting bracket is included with each dimmer to allow easy mounting to scenery. These dimmers are designed and built in the USA by City Theatrical, and pair perfectly with QolorFLEX 5-in-1 LED Tape for ideal use in props and costumes, or for areas where space is a concern.

Accessories for 5942/5943 Dimmers:

PART NUMBER	NAME
5950	XLR5M and XLR5F to Three Position Phoenix Connector, Female, 6"
5984	Antenna, Omni, 900MHz/2.4GHz, 1.8dBi/3.8DbI Dual Band Stubby
5954	Mounting Plate

**Constant Voltage,
Five-output, Wireless
DMX/RDM dimming**



QolorFLEX®
PROFESSIONAL LED LIGHTING

Key Features

- Wireless or wired DMX input
- Wired DMX output
- Mounting bracket included
- Compatible with all Multiverse and SHoW DMX Neo SHoW IDs
- User selectable choice of 2.4GHz or 900MHz radio (P/N 5942 only)
- DMX termination selector switch
- Per channel level indicator lights, PWM frequency, response time, curve selections, bump buttons with disable function, offsets to balance the point at which each dimmer first turns on (important for perfect low end balance)



PART NUMBER	NAME
5951	Phoenix Connector, Six Position, Female
5952	Phoenix Connector, Three Position, Female
5668	Phoenix Connector, Two Position, Female

QolorFLEX Dimmer Specifications









Name	QolorFLEX 2x2.5A Multiverse Dimmer	QolorFLEX 4x5A Dimmer	QolorFLEX 4x5A DINrail RJ45 Dimmer	QolorFLEX 4x5A DINrail Dimmer
Part Number	5916 (2.4GHz), 5917 (900MHz)	5821	5823	5825
Output Channels	2	Selectable, 1 to 4	4	4
Input Voltage	6-30VDC	12 to 36VDC 20A	12~24VDC	12~24VDC
Max Output per Channel	0.9A @12V	5A	5A	5A
Max Device Output	1.8A	20A@12V	20A	20A
Size L x W x H	3.187" x 0.7" x 0.5" (81 x 18.8 x 12mm)	2.1" x 6.7" x 1.1" (53.4 x 170 x 28mm)	2.1" x 6.7" x 1.1" (53.4 x 110 x 65mm)	2.1" x 4.32" x 2.56" (53.4 x 110 x 65mm)
Weight	0.32 oz (9g)	4.8 oz (0.14 kg)	4 oz (0.11kg)	4 oz. (0.11 kg)
Power Connections	Spring Terminals	Spring Terminals	Spring Terminals	Spring Terminals
Output Connections	Spring Terminals	Spring Terminals	Spring Terminals	Spring Terminals
DMX Connections	Spring Terminals	Spring Terminals	2x RJ45	Spring Terminals
0-10V Connections	N/A	N/A	No	No
User Interface	RDM/USB	4 Button, plus alpha/ numeric display	4 button, plus alpha/ numeric display	4 button, plus alpha/ numeric display
DMX Address	Yes	Yes	Yes	Yes
Curve Selection	Yes - 3	Yes - 99	Yes - 99	Yes - 99
Film & Video Modes	Yes - 5	Yes - 18	Yes - 18	Yes - 18
DMX Termination	N/A	No	No	No
SHoW ID	All Multiverse & Neo	No	N/A	N/A
Bump Buttons	Yes	No	No	No
Pilot Lights	Yes	Yes	Yes	Yes
Status Light	Yes	No	No	No
Smoothing Settings	Yes - Variable 6	No	No	No
Stand Alone Levels	No	Yes	Yes	Yes
RDM	Yes	Yes	Yes	Yes
Compliance	5916: CE, RoHS, FCC, AU, Japan, IC 5917: RoHS, FCC, IC	CE, RoHS	CE , RoHS	CE, RoHS















QolorFLEX 5x2.5A Multiverse Dimmer	QolorFLEX 5x8A Dimmer	QolorFLEX 24x3A Dimmer	QolorFLEX 25x3A Dimmer	QolorFLEX Architectural LED PS/Driver Series
5942 (900MHz/2.4GHz), 5943 (2.4GHz)	5809	5810	5811	5758
5	5	24	25	4
5-30VDC	12~24VDC	12~24VDC	12~24VDC	100V-277VAC
4A	8A	3A	3A	3.3A
12.5A	40A	72A	75A	10A
5.63" x 2.75" x 0.63" (143 x 70 x 16mm)	2.88" x 6.5" x 1.5" (73 x 165 x 38mm)	10.24" x 4.72" x 1.57" (260 x 120 x 40mm)	10.24" x 4.72" x 1.57" (260 x 120 x 40mm)	10.5" x 16.15" x 3.56" (266mm x 410mm x 1mm)
2.4 oz (70g)	13.6 oz (0.39 kg)	3 lbs. (1.36kg)	3 lbs. (1.36kg)	14.5 lbs. (6.58kg)
Pluggable connectors	Screw Terminals	Screw Terminals	1 removable Terminal Block Connector (6614)	Hard wire terminals
Pluggable connectors	Screw Terminals	Screw Terminals	5 removable Terminal Block Connectors (6613)	Hard wire terminals
Pluggable connectors	5-Pin XLR, RJ-45, Screw Terminals	5 Pin XLR, RJ-45	etherCON RJ45 Connectors, 5-Pin XLR, and 3-Pin XLR	RJ-45
N/A	No	No	No	User Selectable Sourcing or Sinking
RDM/USB	4 button, plus alpha/ numeric display	4 button, plus alpha/ numeric display	4 recessed buttons, plus alpha/ numeric display	DIP Switches, BCD
Yes	Yes	Yes	Yes	Yes
Yes - 3	Yes - 99	Yes - 99	Yes - 99	Yes - 4
Yes - 5	Yes - 18	Yes - 18	Yes - 18	Yes - 5
N/A	No	No	No	Yes
All Multiverse & Neo	N/A	N/A	N/A	Yes
Yes	No	No	No	N/A
Yes	Yes	Yes	Yes	Yes
Yes	No	No	No	Yes
Yes - Variable 6	No	No	No	Yes - 6
No	Yes	Yes	Yes	No
Yes	Yes	Yes	Yes	Yes
5942: RoHS, FCC, IC 5943: CE, RoHS, FCC, ACMA, ARIB, IC	CE, ROHS	CE, ROHS	CE, ROHS	ETL

QolorFLEX LED Tape Accessories





Ribbon Cables:

P/N	NAME	
6607	Ribbon Cable, Six Conductor, 18 GA	
6607-20	Ribbon Cable, Six Conductor, 20 GA (thinner than 18 GA)	
6600	Ribbon Cable, Five Conductor, 18 GA	
6600-20	Ribbon Cable, Five Conductor, 20 GA (thinner than 18 GA)	
6608	Ribbon Cable, Four Conductor, 18 GA	
6606	Ribbon Cable, Three Conductor, 18 GA	
6605	Ribbon Cable, Two Conductor, 18 GA	

Connectors:

P/N	NAME	
6612	Terminal Block Connector, Six Pin, Male	
6613	Terminal Block Connector, Six Pin, Female	
6610	Terminal Block Connector, Five Pin, Male	
6611	Terminal Block Connector, Five Pin, Female	
5673	Terminal Block Connector, Four Pin Male	
5674	Terminal Block Connector, Four Pin Female	
5671	Terminal Block Connector, Three Pin Male	
5672	Terminal Block Connector, Three Pin Female	
5657	Terminal Block Connector, 2-Pin Male	
5658	Terminal Block Connector, 2-Pin Female	
6615	Female barrel to screw terminal connector	
6616	Male barrel to screw terminal connector	

Extrusions and Diffusers:

P/N	NAME	
6693	Aluminum Extrusion, 45-Degree, 2m for 45-Degree LED Tape installations	
6694	Diffuser for 45-Degree Extrusion, 2m	
6690	Aluminum Extrusion, Low Profile, 2m	
6695	Diffuser for Low Profile Extrusion, 2m	

End Caps, Tape, Clips, and More:

P/N	NAME	
6690-1	End Cap for 6690 Aluminum Extrusion (Pack of 10)	
6690-2	End Cap with hole for 6690 Extrusion (Pack of 10)	
6671-1	End Cap for 6693 45-Deg Extrusion (Pack Of 10)	
6671-2	End Cap with hole for 6693 45-Deg Extrusion (Pack Of 10)	
6680	Waterproof End Caps for Outdoor tapes (Packs of 10)	
6682	9mm w/ 2 holes	
6684	8mm (no holes)	
6684	12mm w/ 4 holes	
6686	12mm (no holes)	
6625	3M VHB Double Sided Tape Roll, 72 yards	
6630	Outdoor Tape Clips and Screws (Pack of 12)	
6632	Clips for 6693 45-Degree Extrusion (Metal) for LED Tape (Pack Of 12)	
5748	QolorFLEX Connect 10. A time saving solution for managing the multiple wire runs and numerous connections needed for large scale installations of LED tape.	
Call for info	QolorFLEX 24V Demo Kit. For easy side-by-side comparisons of our QolorFLEX 24V LED Tape products. Call 201.549.1160 to get started.	

CITY THEATRICAL
NEW YORK • LONDON
An Environmental Lights Company

475 Barell Avenue, Carlstadt, NJ 07072
Phone: 800.230.9497 or 201.549.1160
Fax: 201.549.1161

Office 31, Units 1-3, Beverley Way,
New Malden, KT3 4PH U.K.
Phone: +44 (0) 20 8949 5051