

# **CITY THEATRICAL**

**NEW YORK • LONDON**

## **Multiverse<sup>®</sup> Vero Transceiver 2.4GHz P/N 7400-5903**

### **User's Manual Rev 1.1**

© 2021 City Theatrical, Inc.



Multiverse Transmitters are covered by U.S. Patents #7,432,803 B2, #10,129,964 B1, and other patents pending.

Made in USA

**US HEADQUARTERS  
475 BARELL AVENUE  
CARLSTADT, NEW JERSEY 07072  
TEL 800 230 9497 / 201 549 1160  
FAX 201 549 1161**

**LONDON OFFICE  
UNIT 1-3 WYVERN ESTATE, BEVERLEY WAY  
NEW MALDEN, SURREY KT3 4PH  
TEL +44 (0) 20 8949 5051  
FAX +44 (0) 20 7183 6061**

**[www.citytheatrical.com](http://www.citytheatrical.com)**

## Table of Contents

Compliance.....	3
Safety Notices.....	3
Introduction.....	4
7400-5903 Multiverse® Vero Transceiver Features.....	4
Installation.....	5
Surface Mounting.....	6
Pipe Mounting.....	6
Face Panel.....	7
User Interface Screen.....	8
User Interface Icons.....	10
RDM Settings.....	12
Updating Firmware.....	12
What's Included.....	12
Specifications.....	13
Troubleshooting.....	14

## List of Tables

Table 1: Selecting Your Multiverse SHoW ID.....	10
Table 2: SHoW IDs and SHoW Keys.....	12
Table 3: Included Item Descriptions and Part Numbers.....	13
Table 4: Physical Characteristics.....	14
Table 5: Troubleshooting Guide.....	15
Table 6: Legacy SHoW IDs Guide.....	15

## List of Figures

Figure 1: Surface Mounting Diagram.....	6
Figure 2: Face Panel Diagram.....	7
Figure 3: What's Included.....	13

## Compliance

### FCC Compliance Statement (United States)

This device complies with Part 15 of the Federal Communications Commission (FCC) Rules. Operation is subject to the following two conditions:

1. This device may not cause harmful interference.
2. This device must accept any interference received, including interference that may cause undesired operation.

**CAUTION:** Changes or modifications to this unit not expressly approved by the party responsible for compliance could void the user's authority to operate this equipment.

### IC Statement

This device complies with Industry Canada's license-exempt RSSs. Operation is subject to the following two conditions:

1. This device may not cause interference; and
2. This device must accept any interference, including interference that may cause undesired operation of the device.

Le présent appareil est conforme aux CNR d'Industrie Canada applicables aux appareils radio exempts de licence. L'exploitation est autorisée aux deux conditions suivantes:

1. l'appareil ne doit pas produire de brouillage, et
2. l'utilisateur de l'appareil doit accepter tout brouillage radioélectrique subi, même si le brouillage est susceptible d'en compromettre le fonctionnement.

### Safety Notices

Please read this entire manual before using your new equipment. Please keep the manual in a safe place so you can refer to it in the future as required.

The Multiverse wireless DMX/RDM System is intended for use only by qualified professionals. Connection, installation, and hanging of this equipment must be performed in accordance with all pertinent local, regional, and national safety codes and regulations.

Do not operate in excessive heat/direct sunlight. Be sure installation provides adequate ventilation.

There are no user-serviceable parts inside! Refer to qualified service personnel!

**RF Exposure:** The antenna(s) used for this transmitter must be installed to provide a separation distance of at least 20cm from all persons and must not be collocated or operating in conjunction with any other antenna or transmitter.

## Introduction

The Multiverse® Vero Transceiver 2.4GHz brings the advanced features of the Multiverse wireless DMX/RDM system to outdoor installations for architecture and entertainment. The 7400-5903 Multiverse Vero Transceiver 2.4GHz contains a 2.4GHz radio for worldwide use.

The Multiverse Vero Transceiver is housed in a NEMA 4 / IP66 package that provides protection from the outdoor elements. Its internal backlit LCD display simplifies setup and gives feedback on system performance. Each unit comes with a dual band 2.5dBi Outdoor Omni-directional Antenna.

## 7400-5903 Multiverse Vero Transceiver Features

- **2.4GHz Radio**  
Transmit and receive on the 2.4GHz band for worldwide use.
- **mDMX**  
mDMX is a form of DMX optimized for wireless broadcast that dramatically reduces data being broadcast, thereby reducing unneeded radio energy.
- **mRDM**  
Multiverse is able to broadcast RDM information without disrupting the DMX broadcast. This feature is not available even in wired RDM systems.
- **SHoW Key Security**  
SHoW Key is an optional three-digit code that can be added to the Multiverse SHoW ID that will prevent any other system set on the same SHoW ID from interfering with your system.
- **Forward Error Correction**  
Allows the Receiver to detect and correct errors that may occur in the wireless transmission of data.
- **Ultra Low Latency**  
Total average system latency of 4ms.
- **Adaptive Spread Spectrum Frequency Hopping**  
Adaptive Spread Spectrum Frequency Hopping identifies and masks off hopping channels that contain interference, replacing them in the hop sequence with alternate channels.
- **Adjustable Output Power**  
Sometimes an application calls for the most available broadcast power, but many entertainment systems can utilize lower output power to reduce detrimental effects on other radio systems in the venue, reduce reflections, and improve performance.
- **User Selectable SHoW IDs**  
City Theatrical has always produced wireless DMX products that allowed the user to select the optimum transmission method. Users may select full bandwidth hopping, hopping limited to a section of the spectrum (including areas of the spectrum outside of the Wi-Fi range), or adaptive hopping.

- Protocols supported: ANSI E1.11 DMX512-A; E1.20 RDM
- Built-in Multiverse 2.4GHz Frequency Hopping Spread Spectrum radio
- Compatible with all Multiverse and legacy SHoW DMX Neo products
- User can select a single universe to receive
- Four button user interface screen to set SHoW ID, universe, and other functions
- RDM proxy and responder functions
- DMX In (when used as transmitter) and Out (when used as receiver) via 3 pin Screw Terminal
- Rugged weatherproof aluminum enclosure
- Antenna: Omni Broadband, 2.4GHz 2.5dBi
- User selectable transmit or receive mode
- Firmware updateable via USB port
- Power input 90-277VAC input, 1A max, on 3 pin screw terminals
- User interface selection of DMX512 termination
- Selectable display timeout and brightness level
- A bracket for surface mounting or mounting from a pipe

## **Installation**

Install the Multiverse Vero Transceiver in a suitable location, following the instructions below. For best results the antennas in your system must be within sight of each other.

### **Warning**

To avoid electric shock, do not energize any circuits before all internal and external electrical and mechanical clearances are checked to assure that all assembled equipment functions safely and properly.

### **Important use notes**

This unit must be used with voltages below 600V. This unit must be installed in accordance with the National Electrical Code, ANSI/NFPA 70, where the ambient temperature does not exceed 60°C maximum.

### **Grounding**

This enclosure has been provided with a ground bond jumper for ground connection between the back box and the cover. This jumper must be installed using the provided hardware.

### **Mounting Bracket**

The provided mounting Bracket Base can be mounted on a surface or a vertical pipe. For surface mounting, the Bracket base is provided with slots and holes suitable for #10 / M4 screws or similar fasteners.

## Surface Mounting

Mount the Mounting Bracket Base in the desired location using four #10 / M4 screws (by others, as above).



Slide the mating Mounting Bracket (attached to the Unit) into the Mounting Bracket Base until the locking clip engages, and install the provided 8-18 x .500" SS Thread Forming Torx Button Head Security Screw in the hole on the left side of the Bracket assembly.

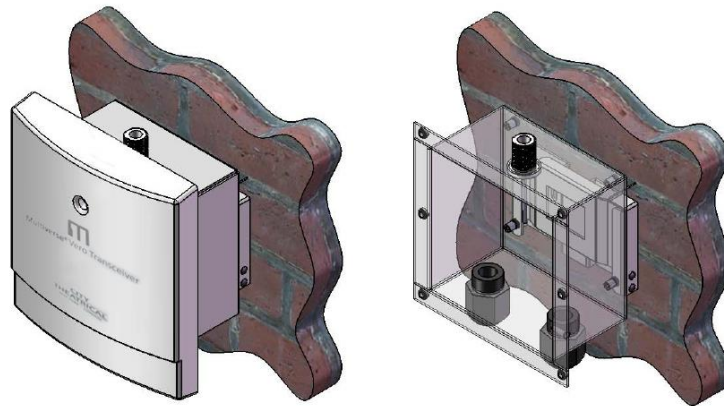

*Figure 1: Surface Mounting Diagram*

## Mounting Orientation

The 7400-5903 Multiverse Vero Transceiver must be mounted exclusively in an upright mounting position with the cable entries on the bottom and antenna connector on the top as shown in the drawing above.

## Pipe Mounting

The Multiverse Vero Transceiver can also be mounted on a pipe. Attach the Mounting Bracket Base to a pipe using a stainless steel hose clamp (not included) as shown:

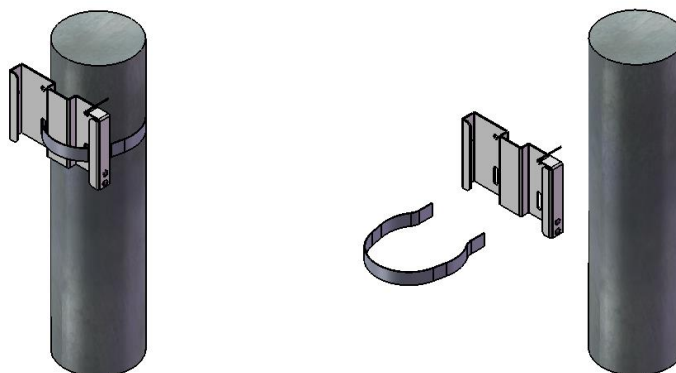

Slide the mating Mounting Bracket (attached to the Unit) into the Mounting Bracket Base until the locking clip engages, and install the retaining Screw.

### Cable or Conduit Entry

The unit enclosure is provided with ½" NPT entry holes fitted with liquid-tight cable grips for use with outdoor use cables (by installer) for power and DMX connection. The recommended torque for these cable grips is as follows:

Locking Nut	40-45 inch pounds
Sealing Nut	50-55 inch pounds

If outdoor use conduit is used instead, it is recommended that the conduit be sealed after installation to prevent moisture entry, including free air exchange, in order to minimize the chance of condensation buildup.

### Face Panel

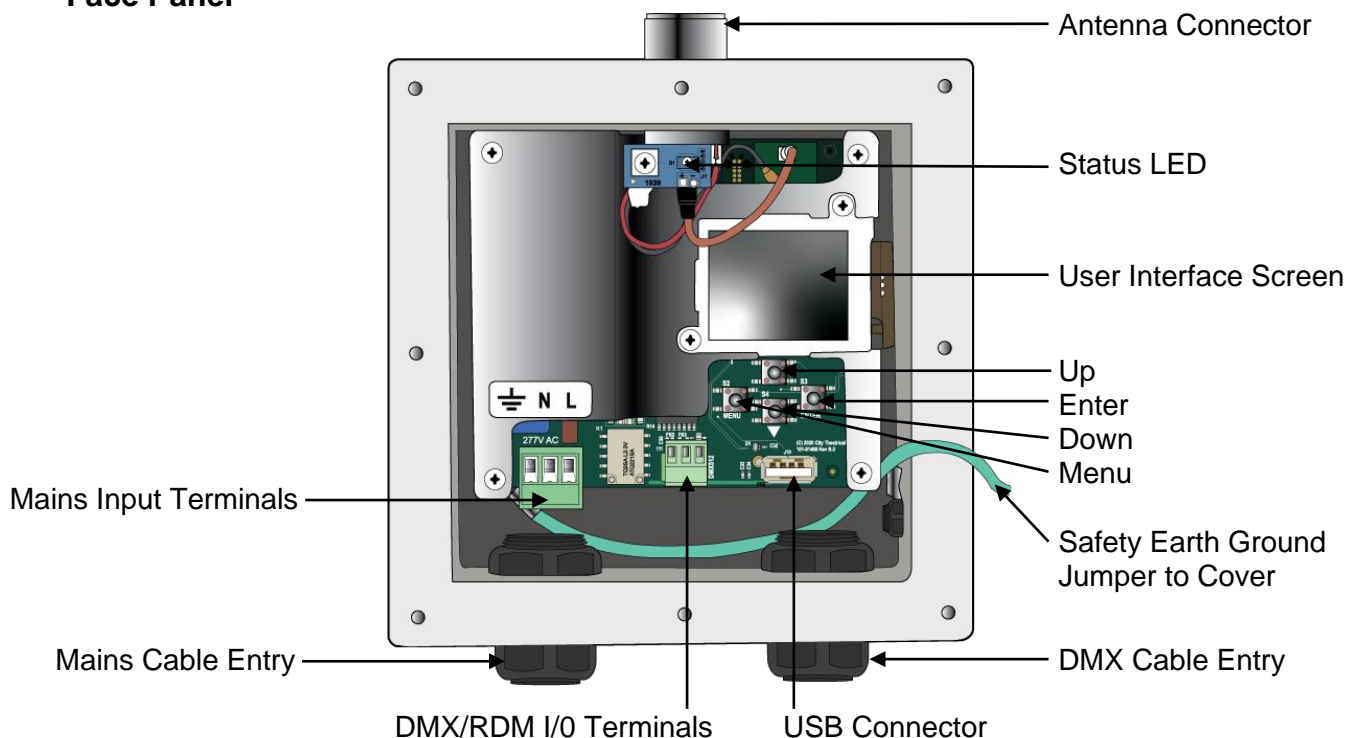

**Figure 2: Face Panel Diagram**

## Mains Wire Installation and Termination

Install the mains cable or conduit in the entry provided as shown in Figure 2 on page 7. A liquid tight cable grip is provided for use with suitable outdoor rated cable with diameter range of .170"/4.3mm - .450"/11.4mm.

When cable is used, strip outer jacket 6"/150mm.

The mains connection is a 3 pos. plug/socket type terminal block which may be disconnected for ease of assembly. Strip insulation from individual conductors .25"/7mm and terminate in the provided screw terminal socket. Mains terminations are are marked on the unit.

## DMX512 Wiring

The Multiverse Vero Transceiver is provided with a PCBA mount terminal block for DMX connection (see illustration above). DMX Input / Output connections are marked on the unit.

## Installing the Cover

The Multiverse Vero Transceiver has a two part cover, with the outer plastic cover connected to the inner metal cover with a hinge. Install the metal inner cover using the eight provided 6-32 x .375" SS Truss Head Machine Screws. Hand install these screws until the screw threads are fully engaged with the mating PEM Nut, then tighten to 4 inch pounds.

The outer cover is then closed and secured with the provided 8-18 x .500" SS Thread Forming Torx Button Head Security Screw, installed in the provided hole on the left side of the cover assembly.

## User Interface Screen

Upon power up, the Multiverse Vero Transceiver 2.4GHz will boot into the main screen, which displays the SHoW ID and connection status. Pressing the "Up" or "Down" button will take you to the universe selection screen. Pressing "Enter" will select SHoW ID or universe for editing and will commit the change when done.



SHoW ID on Tx screen



SHoW ID on Rx screen



Universe on Rx screen



Pressing the “Menu” button will take you to the Menu screen. Holding the Menu button will cancel the current edit. See page 11 for a full description of menu selections.

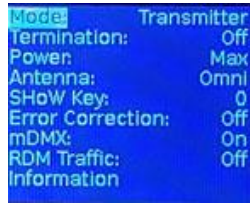

Transmitter menu screen

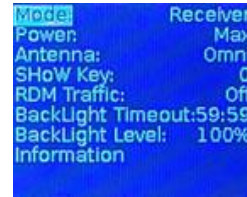

Receiver menu screen

### About SHoW ID

Choosing and setting a SHoW ID is an important part of the Multiverse system. SHoW ID is a number that describes the portion of the spectrum on which the broadcast will take place (such as 2.4GHz), the area of that band where the broadcast will be directed (such as full band, low portion of the band only, high portion of the band only, etc.), and several other factors that influence the broadcast. Those factors are combined into a number called the SHoW ID. See the SHoW ID chart on page 10 for a full explanation.

### Using A Spectrum Analyzer To Choose A SHoW ID

It is a good practice to utilize a device such as City Theatrical’s **P/N 5988 RadioScan™ Spectrum Analyzer** to analyze the spectrum in the area of the broadcast. RadioScan is a 900MHz and 2.4GHz spectrum analyzer, utilizing a hardware dongle and accompanying software, that enables you to easily visualize radio energy that is otherwise invisible to you. Using RadioScan helps you create a broadcast plan that optimizes the available spectrum in your area, and helps prevent interference with other mission critical radio devices near you.

RadioScan will guide you in creating the optimum broadcast plan for your installation by helping choose the best SHoW ID.

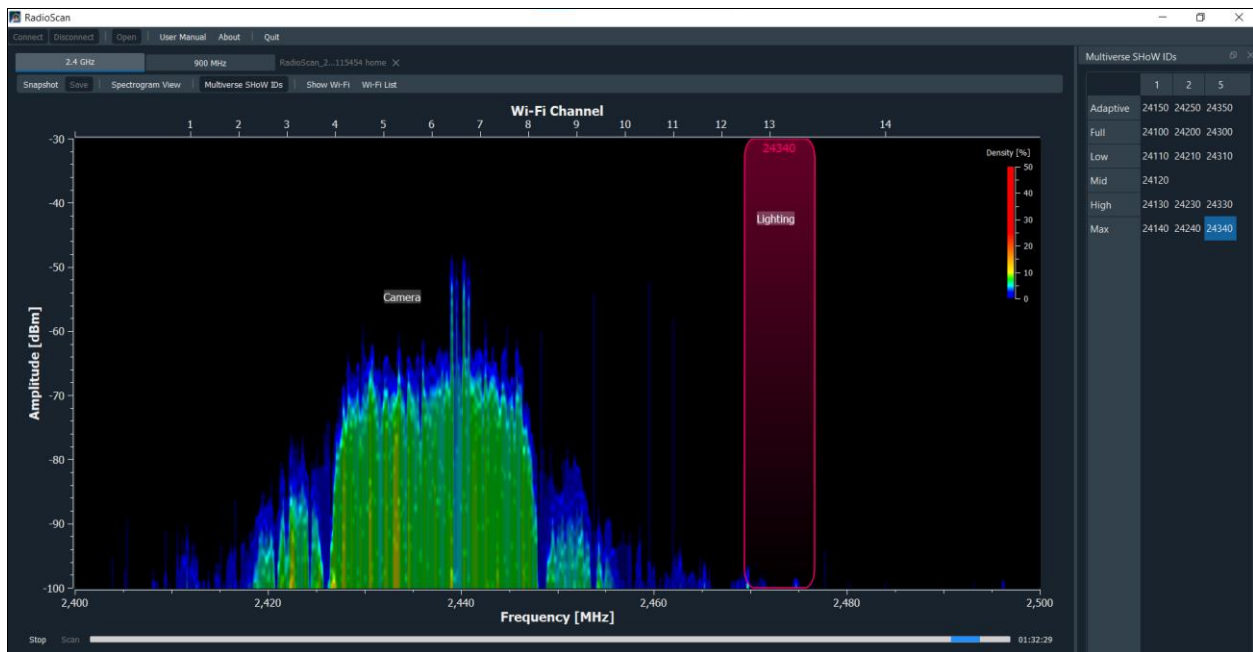

In this image, RadioScan has helped to choose a SHoW ID in the upper end of the spectrum.

If you do not have RadioScan, devices like smartphones often have simple Wi-Fi visualizers which can help guide you to a more open area of the 2.4GHz spectrum.

### Choosing a SHoW ID

In a single universe system with a Multiverse Vero Transceiver used as a transmitter and one or more Multiverse Vero Transceivers used as receivers, simply choose a SHoW ID and enter that SHoW ID into the user interface of the transmitter and all receivers. The universe number must match on transmitter and all receivers.

Here is a closer look at the SHoW ID numbering system:

**Table 1: Selecting Your Multiverse SHoW ID**

### Multiverse SHoW ID Example: 24302

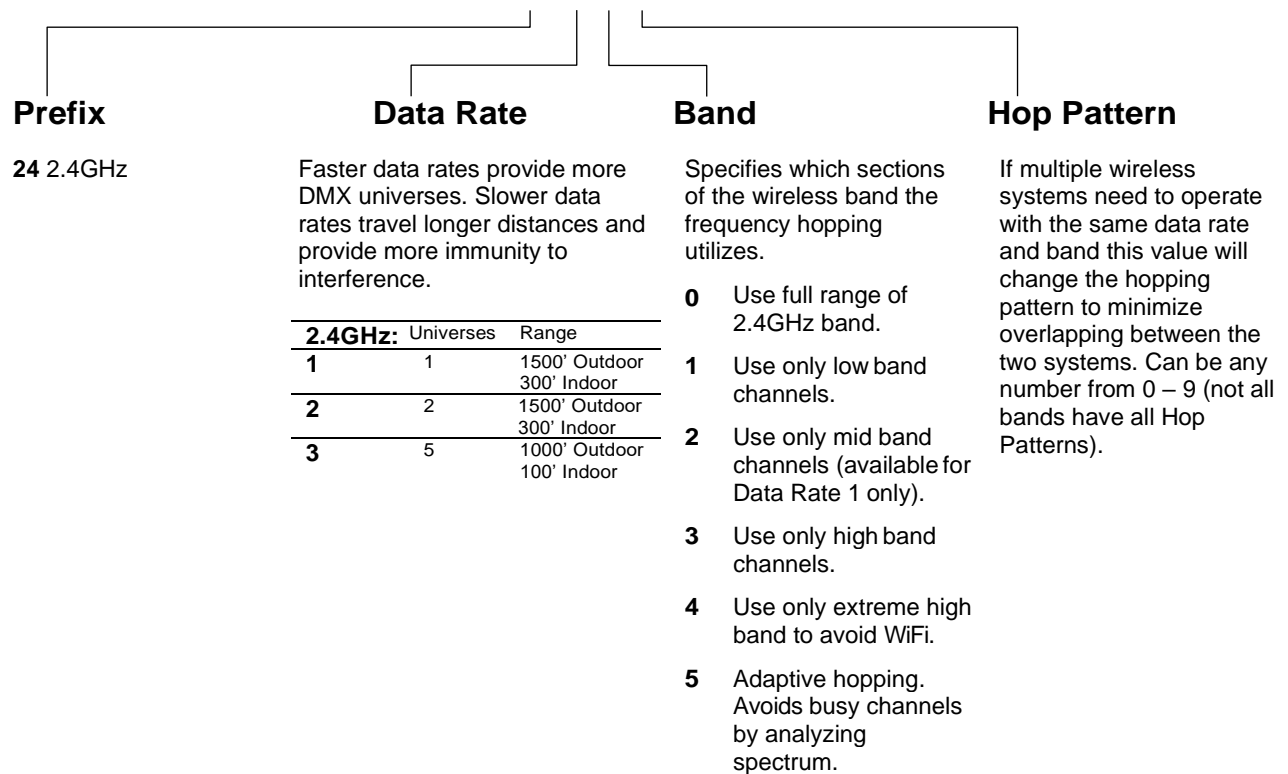

Note: Not all combinations of digits are possible and unused numbers are reserved for future use.

### Universe

Multiple universe systems can be created by adding additional Multiverse Vero units as single universe transmitters. Separate universe numbers must be used for each additional group of transmitters and receivers. Any Multiverse Vero acting as a receiver that is set on a universe that is not being broadcast by a Multiverse Vero acting as a transmitter will show its universe in a yellow color.

## User Interface Icons

At the top of the main screen are several icons that indicate Multiverse Vero Transceiver 2.4GHz status. These include:

- **“TX” or “RX”**  
The Multiverse Vero Transceiver is designated as either a transmitter or receiver on the Menu Screen (see below for instructions). Each unit will display either “TX” (transmitter) or “RX” (receiver) depending on which mode has been selected. The “TX” or “RX” symbol remains solid when DMX data is detected, and blinks if no DMX data is being received.
- **Universe/SHoW ID**  
The display of the SHoW ID and the universe can be toggled back and forth by using the “up” and “down” buttons. Pressing “Enter” will select SHoW ID or universe for editing and will commit the change when done.
- **Signal Quality Bars**  
The signal quality bars give a visualization of signal quality as seen at the receiver. The bars are not present when the unit is a transmitter. Four bars is excellent signal quality, three bars is good signal quality, two bars is fair, and one bar is marginal.
- **Restore Factory Defaults**  
Factory defaults can be restored by holding the “Menu” and “Enter” buttons while on the main screen. Screen will flicker to signal when default process is complete. Default settings are listed below.

## Menu Screen

Pressing the “Menu” button takes you to the Menu screen. The Menu Screen displays different information depending on whether “Mode” is selected as “Receiver” or “Transmitter”.

In “**Receiver**” mode (the default mode), the choices are

- **Mode**  
Select receiver mode or transmitter mode. Default is receiver.
- **Power**  
Output power may be user selected as Low, Med, Hi, or Maximum. It is a best practice to use the least amount of output power to achieve a successful broadcast. This helps to reduce reflections which can reduce signal fidelity, and to reduce any potential negative effect on other radio users in the area. You can monitor signal quality via RDM. Default is Maximum.
- **Antenna**  
If a panel (P/N 5981) or Yagi (P/N 5982) antenna is used instead of the default omni antenna, choose it on this menu for optimum performance and to remain in compliance with FCC and other radio regulations. A P/N 5639 Gender Changer N(m) to N(m) is required to use a panel or Yagi antenna.
- **SHoW Key** (Multiverse SHoW IDs only)

The optional SHoW Key setting allows a user to enter a key to privatize their SHoW ID from another system on the same SHoW ID. SHoW IDs and SHoW Keys need to match in order for receivers and transmitters to talk to each other. Keeping your SHoW Key private will provide a level of security to your Multiverse system from unauthorized use. It is not recommended to use different SHoW Keys in a system that uses multiple Multiverse Veros as Transmitters on the same SHoW ID. The range is 0 (Default) to 500.

**Table 2: SHoW IDs and SHoW Keys**

Situation		Condition	Outcome
Same SHoW Key	with	Different SHoW IDs	OK
Different SHoW Keys	with	Same SHoW IDs	Not OK
Different SHoW Keys	with	Different SHoW IDs	OK

- **RDM Traffic**

The RDM Traffic setting determines whether RDM data is passed downstream of the Multiverse Vero Transceiver. It does not affect whether the Multiverse Vero Transceiver is detectable by devices upstream. It is recommended that RDM be turned off before production situations as many DMX devices do not correctly handle RDM data and may exhibit flickering or other undesired behavior. Default is Off.

- **Backlight Timeout**

The Backlight Timeout setting determines how long the LCD backlight will remain on after the last button press. The timeout can be set to "Off" (backlight will never timeout) or any interval from 10 seconds to 59 minutes 59 seconds. Default is 59 minutes 59 seconds. After a screen timeout, pushing any button will wake up the screen without changing the screen selection.

- **Backlight Level**

Controls Backlight brightness. Range is 1%-100%. Default is 100%.

- **Information**

The Information screen shows the RDM UID, firmware versions present, connection status, and the number of devices (receivers and fixtures) downstream.

In "Transmitter" mode, these additional choices are available:

- **Termination**

If the Multiverse Vero is at the end of the DMX run, set this setting to "On". If more DMX devices are wired after the Multiverse Vero, set this setting to "Off".

- **Error Correction**

High noise environments can affect wireless DMX performance. Enabling Error Correction adds additional information to the data packets to correct errors in slot data that would have otherwise been lost, restoring DMX delivery back to near perfect levels. The extra data reduces the number of slots that can be transported, Max reduces slots by 50%, Med by 33%, Min by 25%. Only needs to be set at the Transmitter. Default is Off.

- **mDMX**  
Improves fidelity while dramatically reducing radio energy broadcast into the spectrum. Only needs to be set at the Transmitter. Default is On.

## RDM Settings

The Multiverse Vero Transceiver can be configured with a compatible RDM controller, such as DMXcat®. All of the settings available through the menu can be set via RDM. Aside from settings, you can also view the Device Model, Manufacturer, Firmware Versions, RDM UID, RF Signal Quality, and quantity of transmit bandwidth in use. You can also give each device a unique RDM Device Label to help with identification for configuration and troubleshooting.

## Updating Firmware

Firmware updates and instructions for performing them are available on the product pages of the City Theatrical website.

## What's Included



**Figure 3: What's Included**

**Table 3: Included Item Descriptions and Part Numbers**

Label in Figure	Item Description	Part Number
1	Multiverse Vero Transceiver 2.4GHz	7400-5903
2	Antenna, Omni Broadband, 2.4GHz 2.5dBi	5983

## Specifications

**Table 4: Physical Characteristics**

<b>Product Information</b>	
Product Name	Multiverse Vero Transceiver (2.4GHz)
Part Number	7400-5903
Maximum Concurrent Universes	1 per transmitter
Frequency Range:	2400 – 2480 MHz

<b>Physical Specifications</b>	
Height	165.0mm (6.5 in)
Width	152.0mm (6.0 in)
Depth	102.0mm (4.0 in)
Weight	0.77kg (1.70 lbs)
Antenna	2.4GHz 2.5dBi
User Interface	Internal Backlit four button LCD display
Construction	NEMA 4 / IP66 Aluminum enclosure
EPA	0.3125ft <sup>2</sup>

<b>Electrical</b>	
Power	90-277VAC input, 1A max, on 3 pin screw terminals
DMX Terminals	DMX In and Out via 3 pin screw termnals

<b>Radio Technology</b>	
Latency	4 ms average
RF Sensitivity	-95dBm
Loss of Data Behavior	Output stops
Broadcast Power	3.2mW, 10mW, 32mW, 100mW EIRP
Broadcast Modes	Adaptive, Full, Low, Mid, High, Max
Show IDs	Multiverse: 217; Neo: 70
RDM Features	RDM Proxy, RDM Responder

<b>Product Information</b>	
Use Environment	Indoor or Outdoor
Operating Temperature	-25°C-60°C
IP Rating	IP66
Compliance	FCC, IC, CE, UKCA, ARIB, cETLus Listed, RoHS
Warranty	One year

## Troubleshooting

**Table 5: Troubleshooting Guide**

Symptom	Solution(s)
Unit does not power up.	Check that power input wiring is properly installed.
	Test power outlet with another device.
Fixtures connected to the receiver are not responding.	Check that the Tx and Rx symbols on transmitters and receivers are solid.
	Check that SHoW ID and SHoW Key (and optional SHoW Key) match on transmitters and receivers.
	Check that universe setting matches on Tx and Rx.

**Table 6: Legacy SHoW IDs Guide**

SHoW DMX Neo SHoW ID	Broadcast Location
201	Adaptive hopping
102	Full bandwidth hopping
117	Low band hopping
133	Mid band hopping
149	High band hopping
165	Max band hopping